

blue

MIL SERIES
DIE & MOULD
SPOTTING
PRESSES





QUALITY, INNOVATION AND TRADITION

MILLUTENSIL is a worldwide leader in the production of **die-mould spotting presses** and **die-splitters** which facilitate safe adjusting, checking and maintenance operations. Founded in 1955, Millutensil always puts the customer first by engineering innovative, first-rate solutions based upon the needs of their customers. In working with top-tier companies across a variety of sectors, Millutensil strives for excellence by developing innovative solutions through cutting-edge technologies. Rather than solely taking on the role of a supplier, Millutensil aims to be partners with their customers, by providing trusted advice and reliable assistance.

WHY INVEST IN A SPOTTING PRESS ?

Some of the fundamental advantages of using a Millutensil die-mould spotting press are as follows:

- Considerable reduction of mould production costs thanks to time and workforce efficiency
- Dies and moulds retain higher quality and longer service life
- Improved safety of both on-site personnel and the mould itself while reducing liability of dangerous lifting methods (cranes, forklift trucks or lifting equipment)
- Optimal accessibility and ergonomics by means of swivelling and tilting plates
- Integrated Rotational Table for the time-saving spotting of multicomponent moulds
- Control of parallelism through high-precision encoders
- Sequencing of hydraulic slides, auxiliary cylinders and ejection systems
- Streamlined operation through intuitive controls of the next generation Siemens Touch Panel
- Modern Diagnostic System
- Wireless SIEMENS Mobile panel with dedicated MILLUTENSIL Software/Industry 4.0 and integrated camera

INDEX

MIL CLASSIC A01



- A01-10 Presse prova stampi - **versione a pavimento**
- A01-10 Tuschierpressen - **Bodenversion**
- A01-10 Die & mould spotting presses - **floor version**
- A01-10 Presse d'essai de Moules - **version sol**

MIL COMPACT B01



- B01-16 Presse prova stampi - **versione a pavimento**
- B01-16 Tuschierpressen - **Bodenversion**
- B01-16 Die & mould spotting presses - **floor version**
- B01-16 Presse d'essai de Moules - **version sol**

TOUCH PANEL C01



- C01-22 Touch panel multipanel
- C01-22 Multipanel touch panel
- C01-22 Touch panel multipanel
- C01-22 Touch panel multipanel

MIL CLASSIC

A02



- A02-12 Presse prova stampi - **versione in fossa**
- A02-12 Tuschierpressen - **Grubenversion**
- A02-12 Die & mould spotting presses - **pit version**
- A02-12 Presse d'essai de Moules - **version fosse**

MIL CLASSIC

A03



- A03-14 Dati tecnici
- A03-14 Technische Daten
- A03-14 Technical data
- A03-14 Données techniques

MIL COMPACT

B02



- B02-18 Presse prova stampi - **versione in fossa**
- B02-18 Tuschierpressen - **Grubenversion**
- B02-18 Die & mould spotting presses - **pit version**
- B02-18 Presse d'essai de Moules - **version fosse**

MIL COMPACT

B03



- B03-20 Dati tecnici
- B03-20 Technische Daten
- B03-20 Technical data
- B03-20 Données techniques

DESCRIPTION

D01



- D01-24 Descrizioni
- D01-24 Beschreibung
- D01-24 Description
- D01-24 Description

ACCESSORIES

E01



- E01-28 Accessori
- E01-28 Zubehörteile
- E01-28 Accessories
- E01-28 Accessoires

MIL CLASSIC



I

Le presse prova stampi della tradizionale serie MIL/CLASSIC sono realizzate con l'uscita del piano estraibile sul fianco laterale, verso il lato stretto del passaggio colonne. Il campo di applicazione è il classico settore della plastica, gomma e pressofusione. Questa soluzione permette l'eventuale ribaltamento sul lato corto del piano estraibile fino a 70° su entrambi i lati. In questa versione anche il piano superiore viene ribaltato sul lato corto da 100° fino a 180°.

La serie MIL/CLASSIC offre, rispetto ad altre soluzioni che ruotano invece il lato lungo, notevoli vantaggi:

- Migliore ergonomia di lavoro con possibilità per l'operatore di accedere agevolmente e senza l'ausilio di pedane a qualsiasi parte dello stampo;
- Altezza totale da terra della pressa molto più contenuta che spesso evita inutili costi per fondazioni;
- Struttura della pressa a "pianta larga" a vantaggio della stabilità;
- I due semistampi si presentano agli operatori sullo stesso fronte, offrendo una visibilità di insieme dello stampo e garantendo una maggiore comodità di lavoro.

EN

The die & mould spotting presses of the traditional MIL/CLASSIC series feature the extensible plate exit on the side, towards the short side of the distance between columns. They are typically used in the plastics, rubber and die casting sectors. This solution allows tilting on the extensible plate short side up to 70° on both sides. In this version, the upper plate, too, is tilted on the short side from 100° to 180°.

The MIL/CLASSIC series provides great advantages compared to other solutions with long side rotation:

- Better working ergonomics, granting the operator to have easy access to any mould part without the use of platforms;
- Much shorter total press height above ground, which often reduces excess costs for foundations;
- Wide base press structure with greater stability;
- The two mould-halves are located on the same side, so operators have an overview of the whole mould and can work more comfortably.

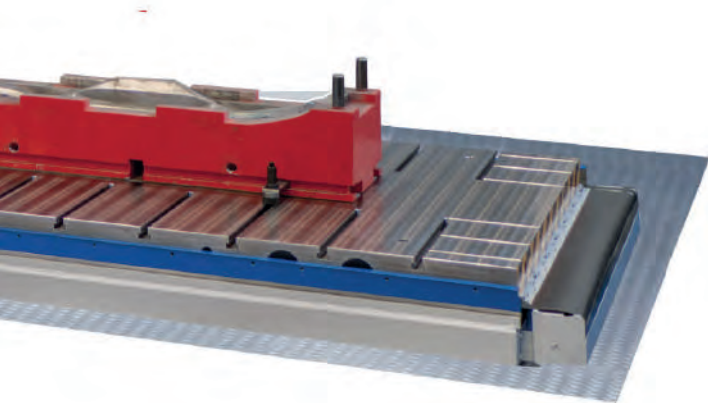
**D**

Die Tuschierpressen der traditionellen Serie MIL/CLASSIC weisen das Ausfahren des Ausziehtisches auf der Seite, in Richtung des schmalen Durchgangs zwischen den Säulen auf. Der Anwendungsbereich ist der typische Kunststoff-, Gummi- und Druckgussbereich. Diese Lösung erlaubt das eventuelle Kippen auf der Schmalseite des Ausziehtisches bis 70° beiderseitig. In dieser Ausführung wird auch der Obertisch auf der Schmalseite von 100° bis 180° gekippt.

Im Vergleich zu anderen Lösungen mit Kippen auf der langen Seite, bietet die Serie MIL/CLASSIC grosse Vorteile:

- Bessere Arbeitsergonomie, mit der Möglichkeit für den Bediener, bequem und ohne Trittbretter jedes Formteil zu erreichen;
- Sehr niedrige gesamte Höhe über Boden der Presse, was oft unnötige Fundamentkosten vermeidet;
- Breite Struktur der Presse für eine bessere Stabilität;
- Die zwei Formenhälften sind auf derselben Seite angeordnet und das bietet den Bedienern eine Gesamtformübersicht und eine grössere Arbeitsbequemlichkeit.

F

Les presses d'essai de moules de la traditionnelle série MIL/CLASSIC sont réalisées avec la sortie latérale du plateau extractible, vers le côté étroit du passage entre les colonnes. Le champ d'application est le secteur classique de la plastique, du caoutchouc et du moulage sous pression. Cette solution permet le basculement éventuel sur le côté court du plateau extractible jusqu'à 70° sur les deux côtés. Dans cette version, le plateau supérieur aussi est basculé sur le côté court de 100° à 180°.

La série MIL/CLASSIC offre, par rapport à d'autres solutions avec rotation du côté long, des avantages considérables:

- Une meilleure ergonomie de travail avec la possibilité pour l'opérateur d'accéder facilement à toute partie du moule sans l'utilisation de plate-formes;
- Hauteur totale du sol de la presse beaucoup plus basse, ce qui souvent évite des coûts inutiles pour les fondations;
- Structure large de la presse pour une meilleure stabilité;
- Les deux demi-moules se présentent aux opérateurs sur le même côté, ce qui offre une vision d'ensemble du moule et garantit plus de confort de travail.

CLASSIC SOLUTION,
INNOVATION AND
EFFICIENCY

MIL COMPACT



I

Le presse prova stampi serie MIL/COMPACT costituiscono una interessante variante per ottimizzare l'aggiustaggio nel settore della pressofusione. Esse sono realizzate con l'uscita del piano estraibile posteriormente verso il lato più lungo del passaggio colonne. In questo settore, infatti, gli stampi hanno dimensioni relativamente poco grandi, ma spesso sono dotati di slitte interne movimentate da cilindri ausiliari molto lunghi che ne aumentano notevolmente l'ingombro totale.

La serie MIL/COMPACT offre pertanto notevoli vantaggi:

- Svolgimento delle operazioni di aggiustaggio su una pressa di dimensioni inferiori e pertanto più economica con conseguente riduzione dei tempi di ammortamento dell'investimento;
- Movimentazione di stampi con cilindri ausiliari molto lunghi senza la necessità di smontarli con conseguente notevole risparmio di tempo;
- Possibilità di realizzare l'uscita posteriore del piano con corse speciali.

EN

The MIL/COMPACT series die & mould spotting presses are a riveting innovation to optimise adjusting in the die casting sector. They feature the extensible plate exit on the backside, towards the longest side of the gap between columns. In this sector moulds are relatively small, but they are often equipped with internal sliding beds that are driven by very long auxiliary cylinders, considerably increasing the total dimensions of the mould overall.

Therefore, the MIL/COMPACT series provides significant benefits:

- Carrying out adjusting operations on a smaller and therefore cheaper press with subsequent reduction of the investment amortisation period;
- Handling of moulds with very long auxiliary cylinders without the need to disassemble them, providing substantial time-saving gains;
- Possibility to design the plate exit on the backside with special travels.

D

Die Tuschierpressen Serie MIL/COMPACT sind eine interessante Variante, welche das Tuschieren im Druckgussbereich optimiert. Sie weisen das Ausfahren des Ausziehtisches auf der Rückseite in Richtung längere Seite des Durchgangs zwischen den Säulen auf. In diesem Bereich haben die Formen tatsächlich relativ kleine Abmessungen, sind aber oft mit Innerschiebern versehen, die durch sehr lange Hilfszylinder angetrieben werden, die den Formgesamtraumbedarf beachtlich vergrößern.

Die Serie MIL/COMPACT bietet deshalb grosse Vorteile:

- Durchführung der Tuschierarbeiten auf einer kleineren und deshalb billigeren Presse mit resultierender Verkürzung der Investitionsabschreibungszeiten;
- Steuerung von Formen mit sehr langen Hilfszylindern, ohne sie abbauen zu müssen, mit grossem Zeitersparnis;
- Möglichkeit des Tischausfahrens auf der Rückseite mit Sonderverfahrwegen.

F

Les presses d'essai de moules série MIL/COMPACT sont une variante intéressante pour optimiser l'ajustage dans le secteur du moulage sous pression. Elles sont réalisées avec la sortie du plateau extractible arrière vers le côté plus long du passage entre les colonnes. Dans ce secteur, en effet, les moules ont des dimensions relativement petites, mais souvent ils sont équipés de coulisses intérieures qui sont entraînées par des cylindres auxiliaires très longs qui en augmentent considérablement l'encombrement total.

Par conséquent, la série MIL/COMPACT offre des avantages considérables:

- Exécution des opérations d'ajustage sur une presse plus petite et donc plus économique avec une conséquente réduction des temps d'amortissement de l'investissement;
- Entraînement de moules avec des cylindres auxiliaires très longs sans besoin de les démonter donc avec un gain considérable de temps;
- Possibilité de réaliser la sortie arrière du plan avec des courses spéciales.

COMPACT SOLUTION,
GREAT FLEXIBILITY
AND FUNCTIONALITY

MIL CLASSIC - Floor version



MODELLO - MODELL MODEL - MODELE	MIL 122-123	MIL 142-143	MIL 162-163	MIL 202-203	MIL 252-253	MIL 262-263	MIL 302-303	MIL 304	MIL 305	MIL 306	MIL 307	MIL 408	MIL 409	MIL 509
A	1200	1400	1600	2000	2500	2500	3000	3000	3000	3500	3500	4000	4000	5000
B	1000	1200	1300	1500	1700	2000	2000	2000	2400	2400	2500	2500	4000	2500
C	1200	1350	1400	1700	1900	2200	2200	2200	2600	2600	2800	2800	2800	2800
D	100°	250	250	400	500	500	500	500	600	600	600	600	600	600
	150°	250	250	200	200	200	200	200	600	600	600	600	600	600
E	100°	950	1100	1000	1200	1400	1700	1700	2000	2000	2200	2200	2200	2200
	150°	950	1100	1200	1500	1700	2000	2000	2000	2000	2200	2200	2200	2200
F	1100	1300	1370	1630	1830	2130	2130	2130	2500	2500	2650	2650	2650	2650
G	1300	1540	1700	2130	2730	2730	3200	3200	3200	3700	3700	4190	4190	4190
H	1920	2150	2280	2610	3180	3180	3680	3680	3680	4250	4250	4900	4900	4900
I	1550	1800	1840	2130	2400	2700	2900	2900	3300	3300	3450	3450	3450	3450
L	4550	5000	5310	6150	7350	7350	8500	8500	8500	9600	9600	10800	10800	10800
M	1760	2000	2180	2690	3320	3320	3970	3970	3970	4500	4500	5050	5050	5050
N	100°	3800	4100	4200	4800	5250	5850	6150	6150	6850	6850	7350	7700	7700
	150°	3800	4100	4200	4850	5550	6150	6450	6450	6850	6850	7350	7700	7700
O	DIN. 650	T.18	T.18	T.22	T.22	T.28	T.28	T.28	T.28	T.28	T.28	T.28	T.28	T.28
P	600	600	610	770	900	900	1050	1050	1050	1050	1050	1400	1400	1400
Q	Ø120	Ø140	Ø150	Ø180	Ø200	Ø200	Ø280	Ø280	Ø280	Ø280	Ø280	Ø300	Ø300	Ø300
R	150°	2600	2900	3000	3500	3900	4600	4700	4700	5400	5400	5700	5700	5700
S	150°	1050	1100	1160	1370	1500	1900	1800	1800	2100	2100	2250	2250	2250
T	1300	1550	1600	1700	1950	2250	2200	2200	2600	2600	2700	2700	2700	2700
U	870	850	850	850	850	850	850	850	850	850	850	850	850	850
V	150°	300	300	330	370	400	400	450	450	450	450	450	450	450
Z	1000	1050	1240	1450	1700	1700	1950	1950	1950	2000	2250	2600	2600	2600

- PRESSE PROVA STAMPI - **VERSIONE A PAVIMENTO**
- TUSCHIERPRESSEN - **BODENVERSION**
- DIE & MOULD SPOTTING PRESSES - **FLOOR VERSION**
- PRESSE D'ESSAI DE MOULES - **VERSION SOL**

MIL CLASSIC

A01

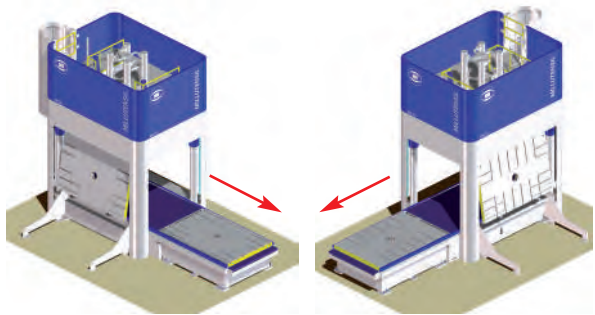
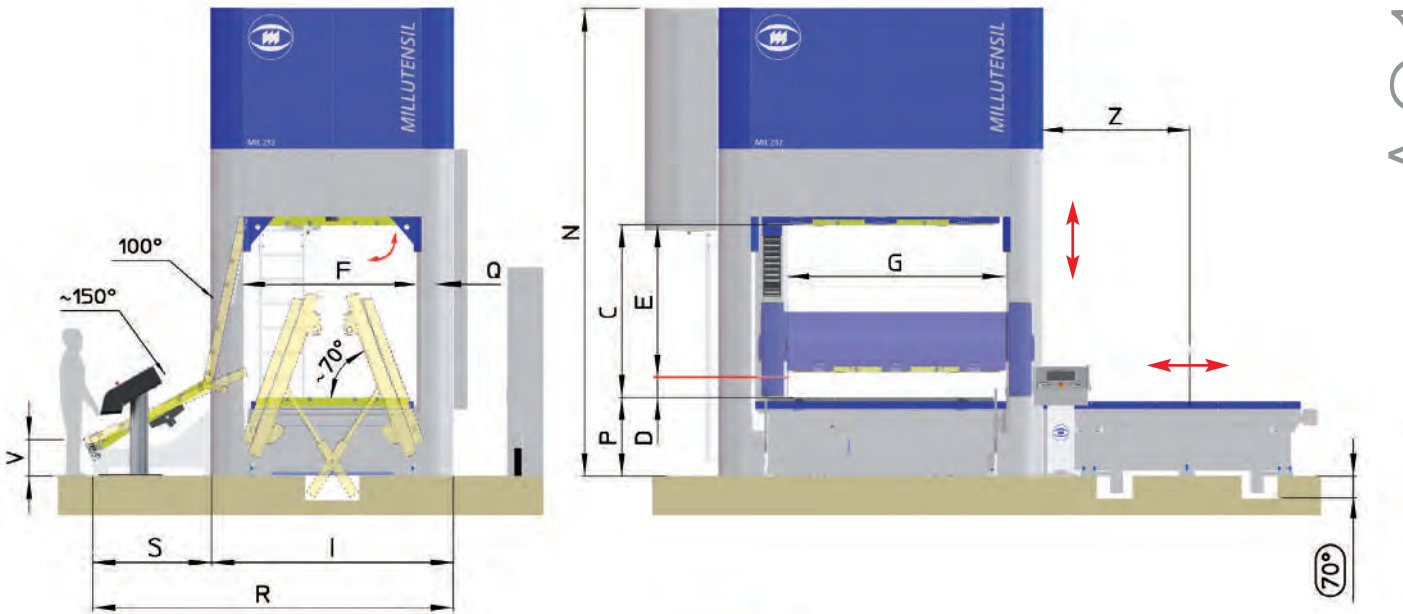

STANDARD
 Versione destra
 Rechte Version
 Right Version
 Version droite

OPTIONAL
 Versione sinistra
 Linke Version
 Left Version
 Version gauche

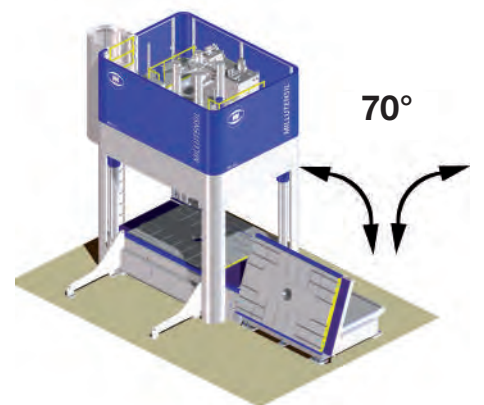
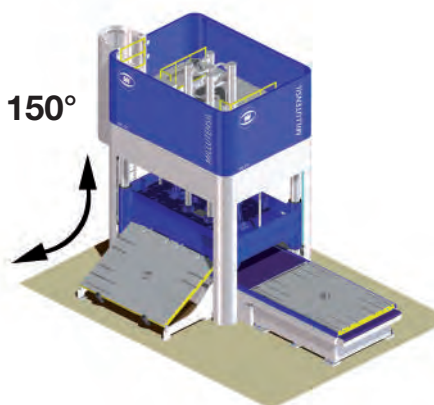
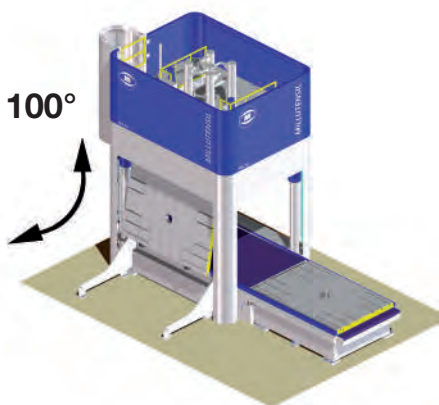
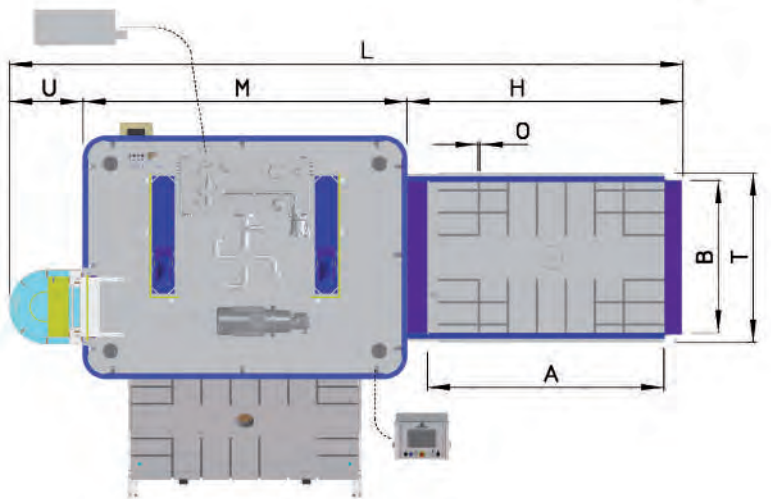

150° OPTIONAL

70° OPTIONAL

MIL CLASSIC - Pit version



MODELLO - MODELL MODEL - MODELE	MIL 252-253	MIL 262-263	MIL 302-303	MIL 304	MIL 305	MIL 306	MIL 307	MIL 408	MIL 409	MIL 509
A	2500	2500	3000	3000	3000	3500	3500	4000	4000	5000
B	1700	2000	2000	2000	2400	2400	2500	2500	4000	2500
C	100°	1900	2200	2200	2200	2600	2600	2800	2800	2800
	180°	2100	2400	2400	2400	2800	2800	3000	3000	3000
D	100°	500	500	500	500	600	600	600	600	600
	180°	300	300	300	300	400	400	400	400	400
E	100°	1400	1700	1700	1700	2000	2000	2200	2200	2200
	180°	1800	2100	2100	2100	2400	2400	2600	2600	2600
F	1830	2130	2130	2130	2500	2500	2650	2650	2650	2650
G	2730	2730	3200	3200	3200	3700	3700	4190	4190	4190
H	3180	3180	3680	3680	3680	4250	4250	4900	4900	4900
I	2400	2700	2900	2900	3300	3300	3450	3450	3450	3450
L	7350	7350	8500	8500	8500	9600	9600	10800	10800	10800
M	3320	3320	3970	3970	3970	4500	4500	5050	5050	5050
N	100°	4350	4980	5150	5150	5850	5850	6300	6500	6500
	180°	4950	5580	5750	5750	6450	6450	6900	7100	7100
O	DIN. 650	T.28	T.28	T.28	T.28	T.28	T.28	T.28	T.28	T.28
P	930	930	1050	1050	1050	1050	1050	1200	1200	1200
Q	Ø 200	Ø 200	Ø 280	Ø 280	Ø 280	Ø 280	Ø 280	Ø 300	Ø 300	Ø 300
R	180°	4150	4700	4900	4900	5700	5700	5950	5950	5950
S	180°	1750	1750	2000	2000	2400	2400	2500	2500	2500
T	4200	4200	4600	4600	5000	5000	5000	5000	5000	5000
T1	7500	7500	8500	8500	8500	10000	10000	11000	11000	11000
U	850	850	850	850	850	850	850	850	850	850
V	180°	500	500	500	500	600	600	600	600	600
Z	1700	1700	1950	1950	1950	2000	2250	2600	2600	2600

- PRESSE PROVA STAMPI - **VERSIONE IN FOSSA**
- TUSCHIERPRESSEN - **GRUBENVERSION**
- DIE & MOULD SPOTTING PRESSES - **PIT VERSION**
- PRESSE D'ESSAI DE MOULES - **VERSION FOSSE**

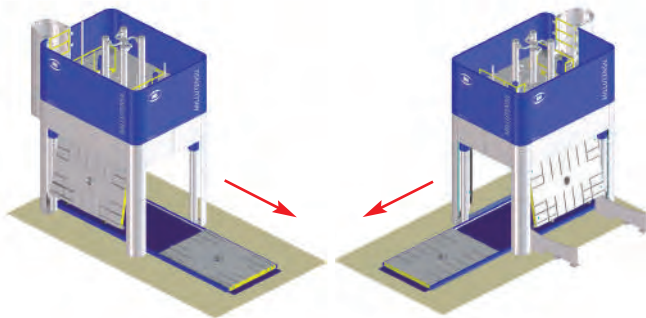
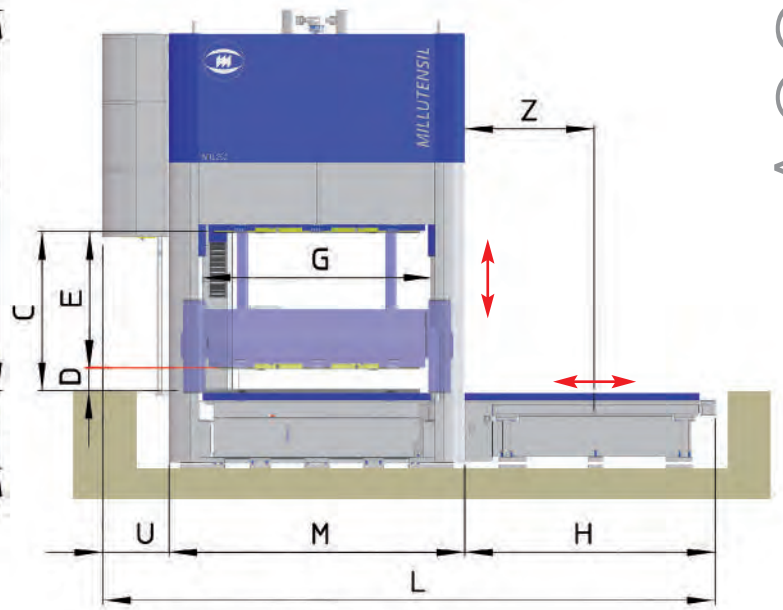
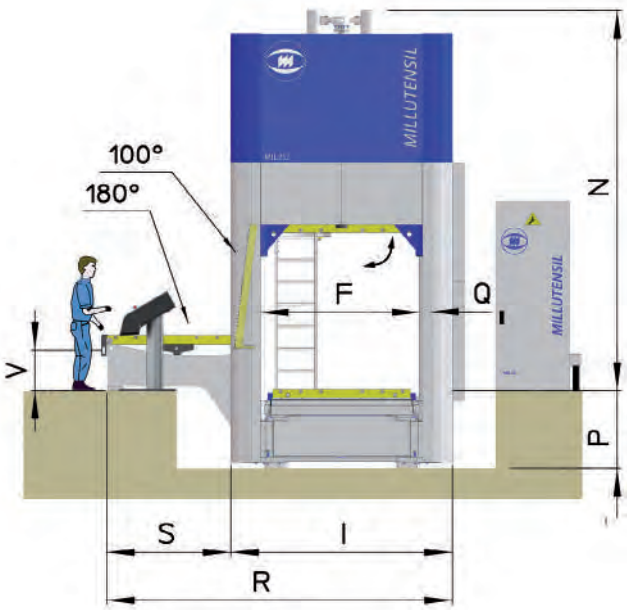

STANDARD
 Versione destra
 Rechte Version
 Right Version
 Version droite

OPTIONAL
 Versione sinistra
 Linke Version
 Left Version
 Version gauche

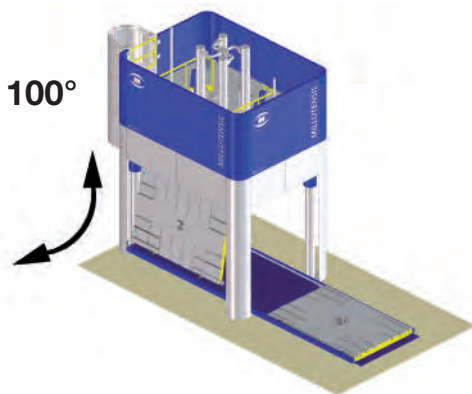
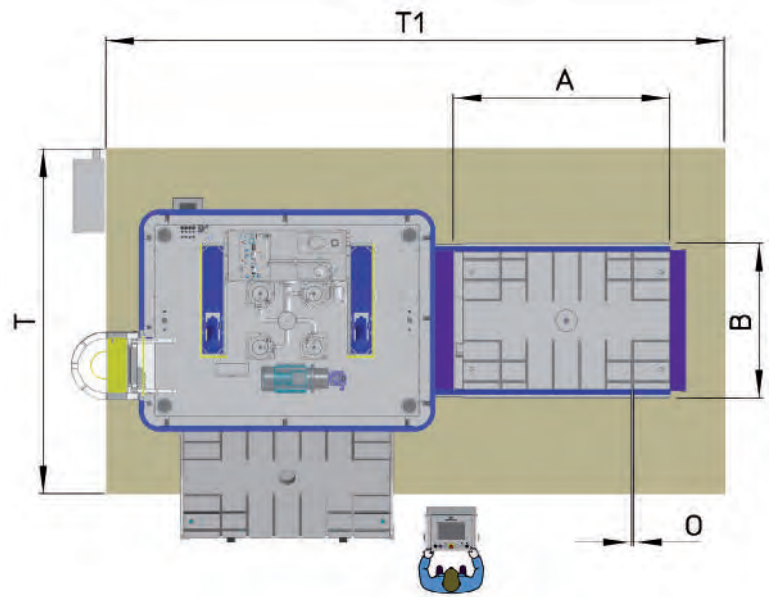

100° STANDARD

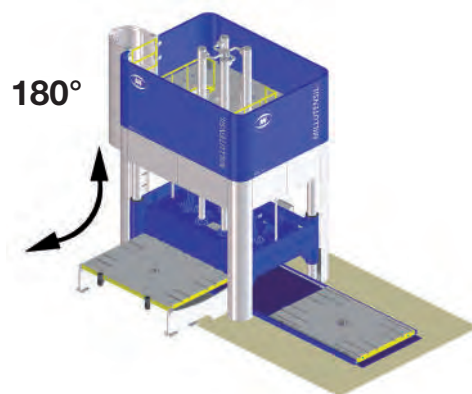

180° OPTIONAL

CLASSIC MODELLO - MODELL MODEL - MODELE		MIL 122-123	MIL 142-143	MIL 162-163	MIL 202-203	MIL 252-253	MIL 262-263	MIL 302-303	MIL 304	MIL 305	MIL 306	MIL 307	MIL 408	MIL 409	MIL 509
Dimensione dei piani Tischaufspannfläche Platens dimension Dimensions des plateaux	mm	1200 x 1000	1400 x 1200	1600 x 1300	2000 x 1500	2500 x 1700	2500 x 2000	3000 x 2000	3000 x 2000	3000 x 2400	3500 x 2400	3500 x 2500	4000 x 2500	4000 x 4000	5000 x 2500
Forza max. chiusura Max. Schliesskraft Max. clamping force Force max. de fermeture	kN	Mil 122 600 Mil 123 800	Mil 142 700 Mil 143 1000	Mil 162 1000 Mil 163 1500	Mil 202 1200 Mil 203 1500	Mil 252 1500 Mil 253 2000	Mil 262 1500 Mil 263 2000	Mil 302 2500 Mil 303 3000	4000	4000 / 5000	4000 / 5000	4000 / 5000	4000 / 5000	5000 / 6000	4000 / 5000
Forza max. apertura Max. Rückzugskraft Max. opening force Force max. d'ouverture	kN	Mil 122 120 Mil 123 170	Mil 142 180 Mil 143 220	Mil 162 250 Mil 163 300	Mil 202 300 Mil 203 350	Mil 252 450 Mil 253 550	Mil 262 450 Mil 263 550	Mil 302 700 Mil 303 800	850	900	1000	1000	1500	1500	1500
Peso max. sul piano inferiore Max. Belastbarkeit auf unterem Tisch Max. load capacity on lower platen Poids max. sur le plateau inférieur	kg	Mil 122 6000 Mil 123 7000	Mil 142 8000 Mil 143 10000	16000	30000	40000	45000	70000	70000	75000	80000	80000	100000	130000	100000
Peso max. sul piano superiore Max. Belastbarkeit auf oberem Tisch Max load capacity on upper platen Poids admis pour plateau supérieur	kg	Mil 122 3000 Mil 123 3500	Mil 142 4000 Mil 143 5000	Mil 162 8000 Mil 163 10000	Mil 202 10000 Mil 203 15000	Mil 252 12000 Mil 253 18000	Mil 262 18000 Mil 263 20000	Mil 302 25000 Mil 303 30000	30000	35000	40000	40000	40000	60000	40000
Velocità di avvicinamento Annäherungsgeschwindigkeit Upper platen approaching speed Vitesse d'approche	mm/ sec	50-65	50-65	65-80	65-80	65-80	65-80	65-80	65-80	65-80	65-80	65-80	65-80	65-80	65-80
Velocità di lavoro Arbeitsgeschwindigkeit Upper platen working speed Vitesse de travail	mm/ sec	8	8	8	8	8	8	8	8	8	8	8	8	8	8
Velocità di ritorno Rücklaufgeschwindigkeit Upper platen back speed Vitesse de retour	mm/ sec	35-50	35-50	35-50	35-50	35-50	35-50	35-50	35-50	35-50	35-50	35-50	35-50	35-50	35-50
Potenze motori Motorleistungen Motors power Puissance du moteur	kW	5,5	7,5	11	11	22	22	30	45	45	45	45	55	55	55
Peso totale Gesamtgewicht Total weight Poids total	kg	Mil 122 10000 Mil 123 11000	Mil 142 13000 Mil 143 14000	Mil 162 18000 Mil 163 19000	Mil 202 27000 Mil 203 28000	Mil 252 44000 Mil 253 45000	Mil 262 55000 Mil 263 56000	Mil 302 84000 Mil 303 85000	90000	105000	125000	135000	150000	150000	150000

MIL CLASSIC - Specifications

A03



MIL COMPACT - Floor version



MODELLO - MODELL MODEL - MODELE	MIL 2015	MIL 2520	MIL 3020	MIL 3025	MIL 3525	MIL 3030	MIL 3530	MIL 4030	MIL 4040
A	2000	2500	3000	3000	3500	3000	3500	4000	4000
B	1500	2000	2000	2500	2500	3000	3000	3000	4000
C	100°	1700	2100	2200	2500	2500	2850	2850	*
	150°	1700	2100	2200	2500	2500	2850	2850	*
D	100°	500	400	500	500	500	500	500	*
	150°	200	200	200	400	400	400	400	*
E	100°	1200	1700	1700	2000	2000	2350	2350	*
	150°	1500	1900	2000	2100	2100	2450	2450	*
G	2130	2620	3130	3130	3600	3150	3650	4150	*
H	2140	2370	2400	3050	3050	3900	3900	3900	*
I	2130	2380	2400	2400	2400	2400	2400	2400	*
L	4270	4750	4800	5450	5450	6300	6300	6300	*
M	2700	3330	3950	3950	4500	4050	4550	5050	*
N	100°	4800	6000	6300	6950	6950	7800	7800	*
	150°	4850	6200	6550	7050	7050	7900	7900	*
O	DIN. 650	T.22	T.28	T.28	T.28	T.28	T.28	T.28	*
P	770	1000	1130	1160	1160	1200	1200	1200	*
Q	Ø 200	Ø 240	Ø 280	Ø 280	Ø 300	Ø 300	Ø 300	Ø 300	*
R	150°	5640	6550	6800	7850	7850	9400	9400	*
S	150°	1370	1800	1800	2400	2400	3100	3100	*
U		850	850	850	850	850	850	850	*
V	150°	370	400	400	400	400	400	400	*
Z		1120	1350	1350	1600	1600	1900	1900	*

* MIL 4040 Lay-out su richiesta | Lay-out auf Anfrage | Lay-out on request | Lay-out sur demande

- PRESSE PROVA STAMPI - **VERSIONE A PAVIMENTO**
- TUSCHIERPRESSEN - **BODENVERSION**
- DIE & MOULD SPOTTING PRESSES - **FLOOR VERSION**
- PRESSE D'ESSAI DE MOULES - **VERSION SOL**

MIL COMPACT

B01

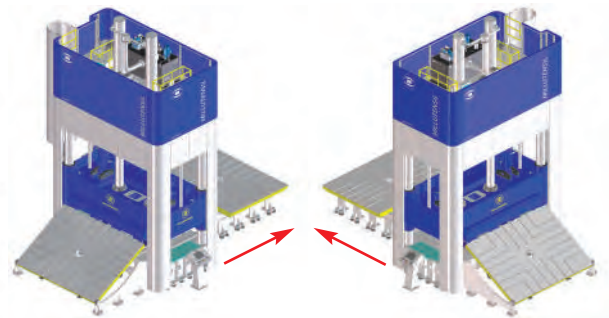
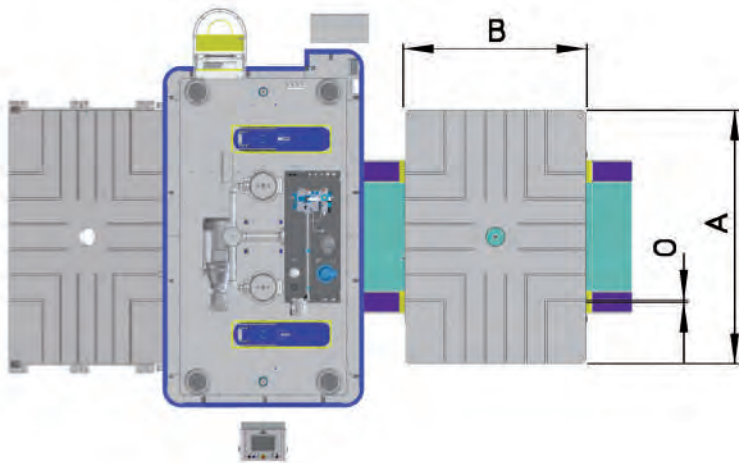
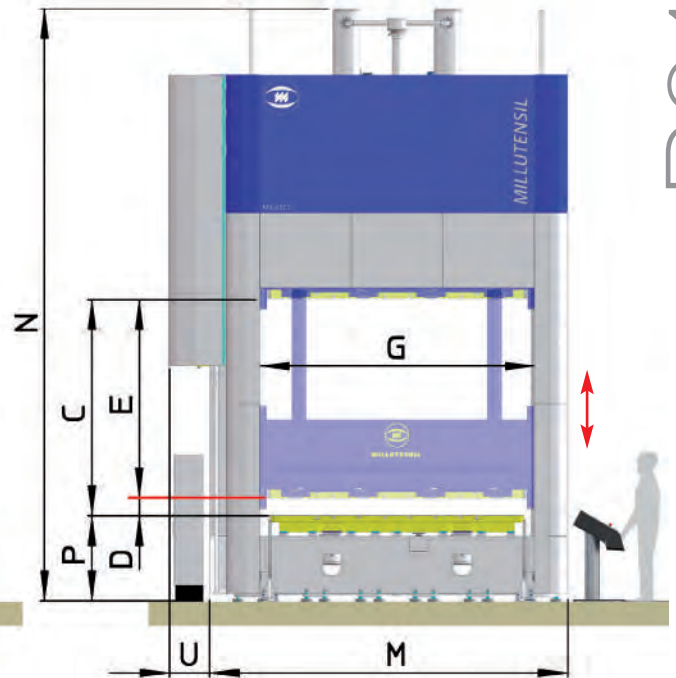
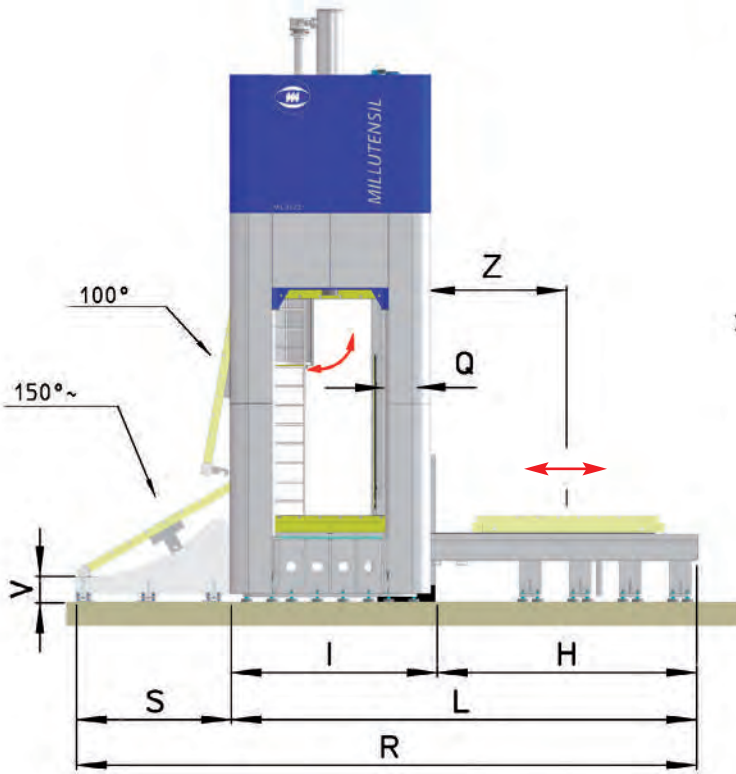

STANDARD
Versione destra
Rechte Version
Right Version
Version droite

OPTIONAL
Versione sinistra
Linke Version
Left Version
Version gauche

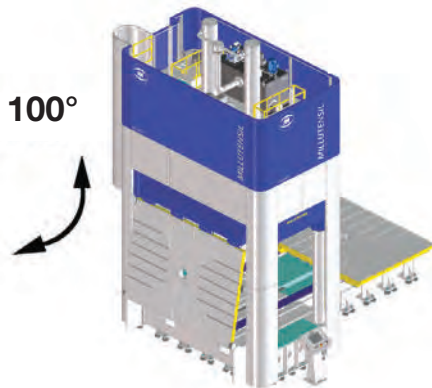

100° STANDARD

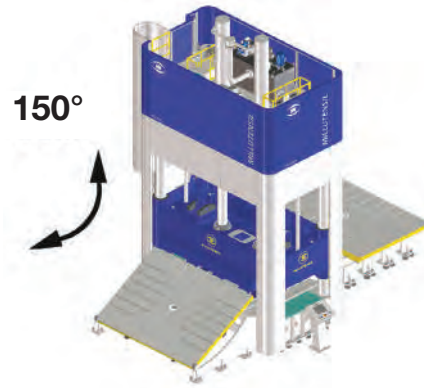

150° OPTIONAL

MIL COMPACT - Pit version



MODELLO - MODELL MODEL - MODELE	MIL 2520	MIL 3020	MIL 3025	MIL 3525	MIL 3030	MIL 3530	MIL 4030	MIL 4040*
A	2500	3000	3000	3500	3000	3500	4000	4000
B	2000	2000	2500	2500	3000	3000	3000	4000
C	100°	2100	2200	2500	2500	2850	2850	*
	180°	2100	2200	2500	2500	2950	2950	*
D	100°	400	500	500	500	500	500	*
	180°	200	200	200	200	200	200	*
E	100°	1700	1700	2000	2000	2350	2350	*
	180°	1900	2000	2300	2300	2750	2750	*
G	2620	3130	3130	3600	3150	3650	4150	*
H	2370	2400	3050	3050	3900	3900	3900	*
I	2380	2400	2400	2400	2400	2400	2400	*
L	4750	4800	5450	5450	6300	6300	6300	*
M	3330	3950	3950	4500	4050	4550	5050	*
N	100°	5250	5500	6050	6050	6900	6900	*
	180°	5450	5750	6350	6350	7400	7400	*
O	DIN. 650	T.28	T.28	T.28	T.28	T.28	T.28	*
P	750	850	900	900	900	900	900	*
Q	Ø 240	Ø 280	Ø 280	Ø 300	Ø 300	Ø 300	Ø 300	*
R	180°	6720	6800	8100	8100	9700	9700	*
S	180°	1970	2000	2650	2650	3400	3400	*
T		5000	5500	5500	6000	5500	6000	6500
T1		5600	5700	6400	6400	7300	7300	7300
U		850	850	850	850	850	850	850
V	180°	650	650	650	650	700	700	700
Z		1350	1350	1600	1600	1900	1900	1900

* MIL 4040 Lay-out su richiesta | Lay-out auf Anfrage | Lay-out on request | Lay-out sur demande

- PRESSE PROVA STAMPI - **VERSIONE IN FOSSA**
- TUSCHIERPRESSEN - **GRUBENVERSION**
- DIE & MOULD SPOTTING PRESSES - **PIT VERSION**
- PRESSE D'ESSAI DE MOULES - **VERSION FOSSE**

MIL COMPACT

B02

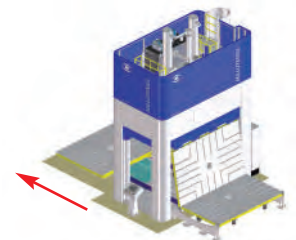
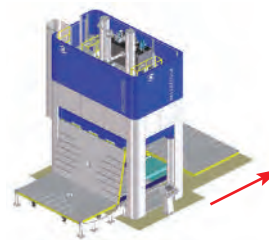
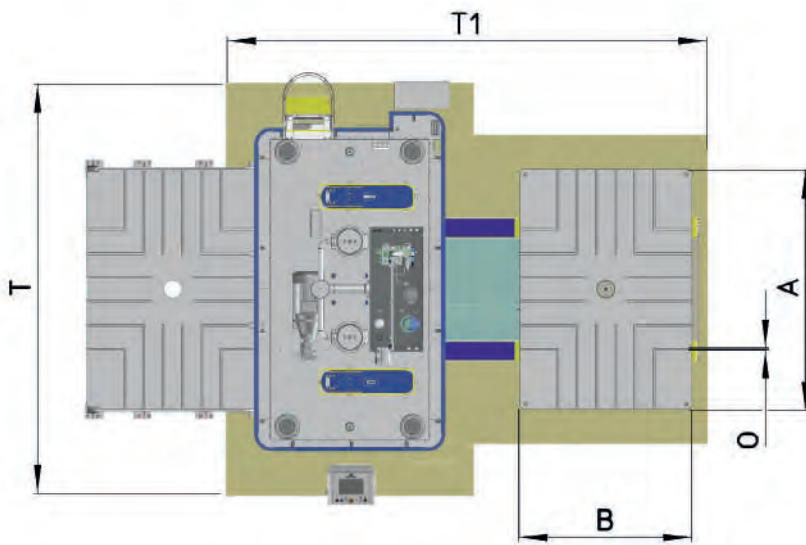
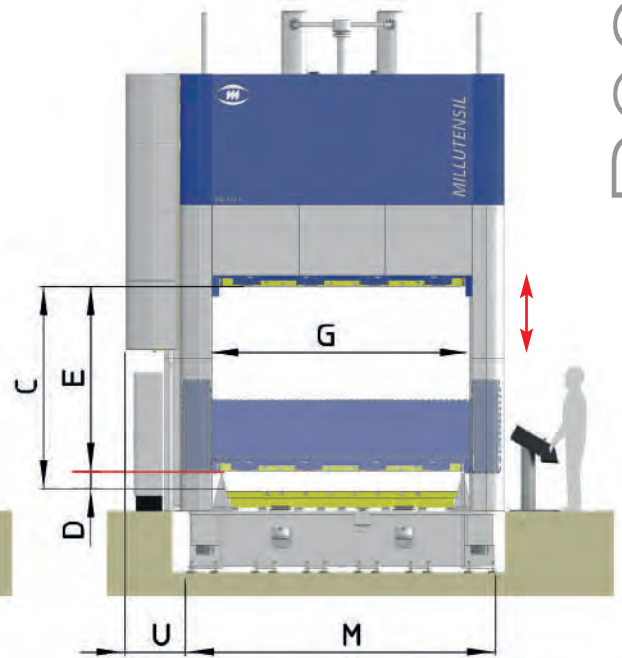
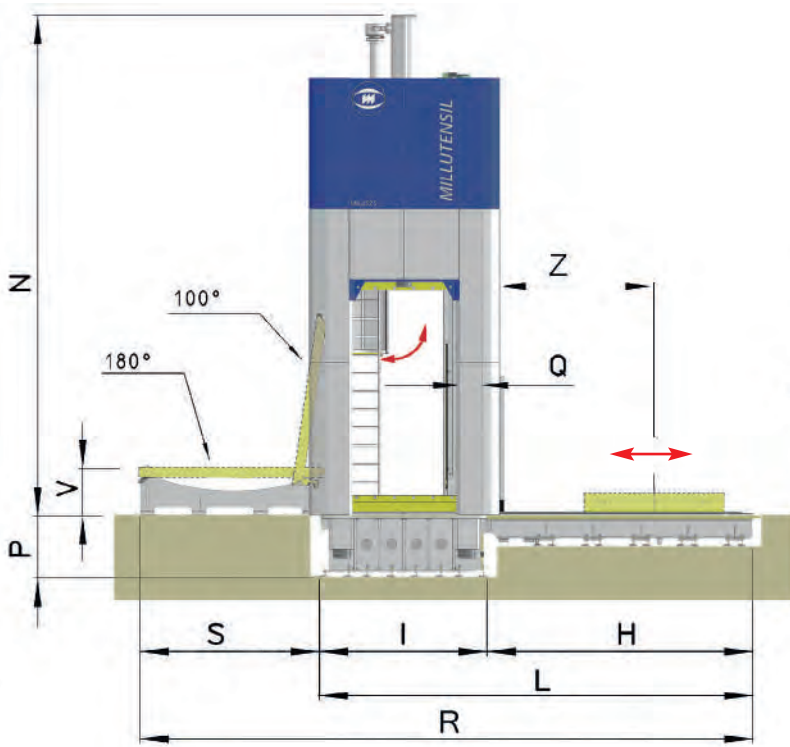

STANDARD
 Versione destra
 Rechte Version
 Right Version
 Version droite

OPTIONAL
 Versione sinistra
 Linke Version
 Left Version
 Version gauche

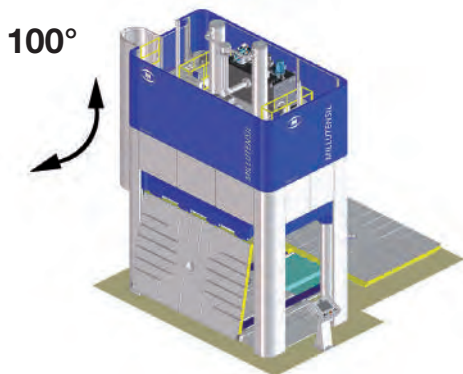

100° STANDARD

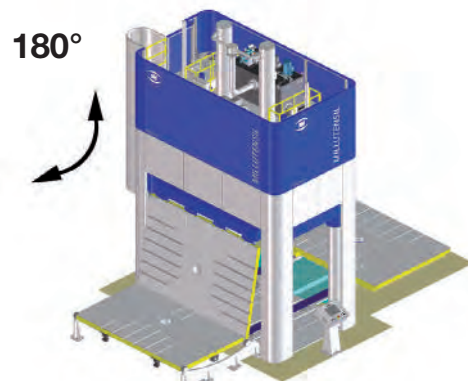

180° OPTIONAL

COMPACT MODELLO - MODELL MODEL - MODELE		MIL 2015	MIL 2520	MIL 3020	MIL 3025	MIL 3525	MIL 3030	MIL 3530	MIL 4030	MIL 4040
Dimensione dei piani Tischauflspanfläche Platens dimension Dimensions des plateaux	mm	2000 x 1500	2500 x 2000	3000 x 2000	3000 x 2500	3500 x 2500	3000 x 3000	3500 x 3000	4000 x 3000	4000 x 4000
Forza max. chiusura Max. Schliesskraft Max. clamping force Force max. de fermeture	kN	1200 / 1500	1500 / 2000	2500 / 3000	2500 / 3000	3000 / 4000	3000 / 4000	3000 / 4000	3000 / 4000	5000 / 6000
Forza max. apertura Max. Rückzugskraft Max. opening force Force max. d'ouverture	kN	350	550	900	900	1000	1000	1000	1000	1500
Peso max. sul piano inferiore Max. Belastbarkeit auf unterem Tisch Max. load capacity on lower platen Poids max. sur le plateau inférieur	kg	30000	45000	48000	50000	55000	60000	70000	80000	130000
Peso max. sul piano superiore Max. Belastbarkeit auf oberem Tisch Max load capacity on upper platen Poids admis pour plateau supérieur	kg	15000	18000	20000	22000	25000	30000	35000	35000	60000
Velocità di avvicinamento Annäherungsgeschwindigkeit Upper platen approaching speed Vitesse d'approche	mm/sec	65-80	65-80	65-80	65-80	65-80	65-80	65-80	65-80	65-80
Velocità di lavoro Arbeitsgeschwindigkeit Upper platen working speed Vitesse de travail	mm/sec	8	8	8	8	8	8	8	8	8
Velocità di ritorno Rücklaufgeschwindigkeit Upper platen back speed Vitesse de retour	mm/sec	35-50	35-50	35-50	35-50	35-50	35-50	35-50	35-50	35-50
Potenze motori Motorleistungen Motors power Puissance du moteur	kW	11	30	30	30	45	45	45	45	45
Peso totale Gesamtgewicht Total weight Poids total	kg	26000	55000	80000	97000	110000	115000	120000	130000	170000

MIL COMPACT - Specifications

B03

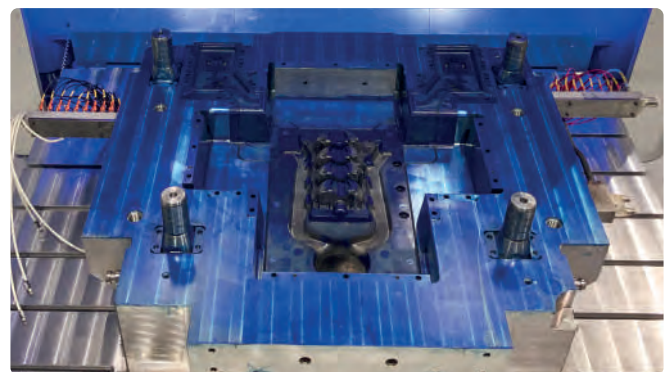
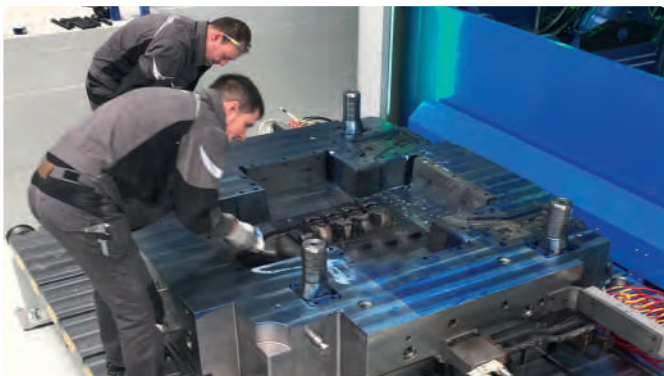

SIEMENS TOUCH PANEL

I

TOUCH PANEL MULTIPANEL PER SERIE MIL

Millutensil è il primo costruttore al mondo ad aver introdotto l'uso del TOUCH PANEL nelle presse prova stampi. Il PLC elettronico "SIEMENS ET200-SP" gestisce tutte le funzioni della pressa.

La visualizzazione avviene tramite un TOUCH PANEL MULTIPANEL "SIEMENS TP1200" di ultima generazione. I vantaggi sono naturalmente il chiaro, facile e comodo utilizzo, così come l'enorme flessibilità nella personalizzazione di alcune funzioni, come per esempio il comando dei cilindri ausiliari.

F

TOUCH PANEL MULTIPANEL POUR LA SERIE MIL

Millutensil est le premier constructeur dans le monde qui a permis l'usage de TOUCH PANEL dans les presses d'essai de moules.

Le PLC électronique "SIEMENS ET200-SP" gère toutes les fonctions de la presse. La visualisation se fait au moyen d'un TOUCH PANEL MULTIPANEL "SIEMENS TP1200" de dernière génération.

Les avantages sont naturellement l'usage clair, facile et confortable, ainsi que la grande flexibilité pour la personnalisation des fonctions, par exemple la commande des cylindres auxiliaires.

D

MULTIPANEL TOUCH PANEL FÜR MIL-SERIE

Millutensil ist weltweit der erste Hersteller, der ein TOUCH PANEL in seine Tuschierpressen einsetzt. Die elektronische PLC "SIEMENS ET200-SP" verwaltet alle Funktionen der Tuschierpresse.

Die Anzeige erfolgt durch ein TOUCH PANEL MULTIPANEL "SIEMENS TP1200" letzter Generation. Die Vorteile sind der einfache, klare sowie bequeme Gebrauch, sowie die enorme Flexibilität der Personalisierung verschiedener Funktionen, wie zum Beispiel die Steuerung der Kernzüge.

EN

MULTIPANEL TOUCH PANEL FOR MIL SERIES

Millutensil was the first manufacturer worldwide to introduce a TOUCH PANEL on its spotting presses.

The electronic PLC "SIEMENS ET200-SP" handles all the functions of the press. Visualization is provided by a next generation Touch Panel Multipanel "SIEMENS TP1200". Uncluttered, clear and ergonomic, the panel offers many advantages as well as vast flexibility in customizing features, including auxiliary cylinder control.



ACCESSORIES

*Integrated
with industry 4.0* 

I

PANNELLO MOBILE WIRELESS SIEMENS / INDUSTRY 4.0

Il tablet ITP1000 è un dispositivo wireless interfacciato direttamente alla pressa pensato per svolgere numerose operazioni aggiuntive rispetto al pannello di controllo principale. Tali operazioni offrono la possibilità di creare facilmente report riguardanti l'aggiustaggio e la manutenzione degli stampi utilizzando i dati memorizzati dalla pressa (ad esempio codice stampo, nome operatore, ore di lavoro, parametri di aggiustaggio ecc.). Tali report possono essere, inoltre, corredati da fotografie e video facilmente eseguibili grazie alla tele-camera integrata, nonché richiamati facilmente in ogni momento.

D

DRAHTLOSES SIEMENS / INDUSTRY 4.0-MOBILGERÄT

Das ITP1000-Tablet ist ein drahtloses Gerät, das unmittelbar mit der Presse verbunden ist, und zur Durchführung von zahlreichen zusätzlichen Funktionen zu denen des Hauptbedienpults entwickelt wurde. Diese Funktionen sehen die Möglichkeit vor, Berichte über die Justierung und die Wartung der Werkzeuge unter Verwendung der durch die Presse gespeicherten Daten (z.B. Werkzeugnummer, Bedienername, Arbeitsstunden, Regulierungsparameter usw.) einfach zu erstellen. Diese Berichte können Fotografien und Videos enthalten, die einfach dank der eingebauten Kamera gemacht werden können, und jederzeit schnell abgerufen werden.

EN

SIEMENS / INDUSTRY 4.0 WIRELESS MOBILE PANEL

The ITP1000 tablet is a wireless device interfaced directly with the press, conceived to perform several additional functions compared to the main control panel. Said functions allow to easily create reports on the adjustment and maintenance of dies and moulds using the data stored by the press (e.g. mould code, operator's name, working hours, adjustment parameters etc.). These reports can also include pictures and videos that can be easily done thanks to an integrated camera, and be easily retrieved at any time.

FR

PANNEAU MOBILE SANS FIL SIEMENS / INDUSTRIE 4.0

La tablette ITP1000 est un dispositif sans fil interfacé directement à la presse, conçu pour effectuer beaucoup d'opérations supplémentaires par rapport à celles du panneau de contrôle principal. Ces opérations offrent la possibilité de créer facilement des rapports sur l'ajustage et l'entretien des moules en utilisant les données enregistrées par la presse (par exemple code de moule, nom opéra-teur, heures de travail, paramètres d'ajustage etc.). Ces rapports peuvent contenir des photos et vidéos, qui sont faciles à réaliser grâce à une caméra intégrée, et peuvent être récupérés facilement à tout moment.



I

**DISPOSITIVI ANTICADUTA
IDROMECCANICI CONTRO LA CADUTA
DEL PIANO SUPERIORE**

2 dispositivi anticaduta idromeccanici sul lato destro e sinistro del piano superiore della macchina che agiscono per l'intera lunghezza della corsa. Il dispositivo brevettato (SITEMA) garantisce un blocco immediato e privo di movimento del piano in caso di calo della pressione idraulica.

D

**HYDROMECHANISCHE FALLSICHERUN-
GEN GEGEN ABSACKEN DES OBEREN
TISCHES**

2 hydromechanische Fallsicherungen an der rechten und linken Seite des oberen Maschinentisches handeln über die gesamte Hublänge. Das patentierte System (SITEMA) garantiert eine sofortige, bewegungsfreie Verriegelung des Tisches bei Abfall des Hydraulikdruckes.

EN

**HYDROMECHANICAL SAFETY DEVICES
AGAINST THE ACCIDENTAL FALL OF THE
UPPER PLATE**

2 hydromechanical fall prevention devices on the right and left sides of the press upper plate operating for the entire stroke length. The patented device (SITEMA) guarantees an immediate motionless locking of the upper plate in case of hydraulic pressure drop.

F

**DISPOSITIFS HYDROMECHANIQUES DE
PROTECTION CONTRE LA CHUTE DU PLA-
TEAU SUPERIEUR**

2 dispositifs antichute hydromécaniques sur le côté droit et le côté gauche du plateau supérieur de la machine agissent pour l'entière longueur de la course. Le dispositif breveté (SITEMA) garantit un verrouillage immédiat et sans mouvement du plateau en cas de baisse de la pression hydraulique.

I

DIVERSAMENTE DALLE CONVENZIONALI BARRE FORATE O DENTATE, CON QUESTO SISTEMA NON HA LUOGO ALCUNA CADUTA DELLA MAZZA DELLA PRESSA IN CASO DI GUASTO DELL'IMPIANTO IDRAULICO

D

IM GEGENSATZ ZU KONVENTIONELLEN LOCH- ODER ZAHNSTANGEN KOMMT ES BEI DIESEM SYSTEM ZU KEINERLEI ABSACKEN DES PRESSENSTÖSSELS BEIM AUSFALL DER HYDRAULIKANLAGE

EN

DIFFERENT FROM CONVENTIONAL MULTI-HOLE OR TOOTHED BARS, THIS SYSTEM PREVENTS THE PRESS RAM FALL IN CASE OF FAILURE OF HYDRAULIC SYSTEM FAILURE

F

DIVERSEMENT DES BARRES PERCEES OU DENTEES CONVENTIONNELLES, CE SYSTEME EMPECHE LA CHUTE DU COULISSEAU DE PRESSE EN CAS DE PANNE DE L'INSTALLATION HYDRAULIQUE

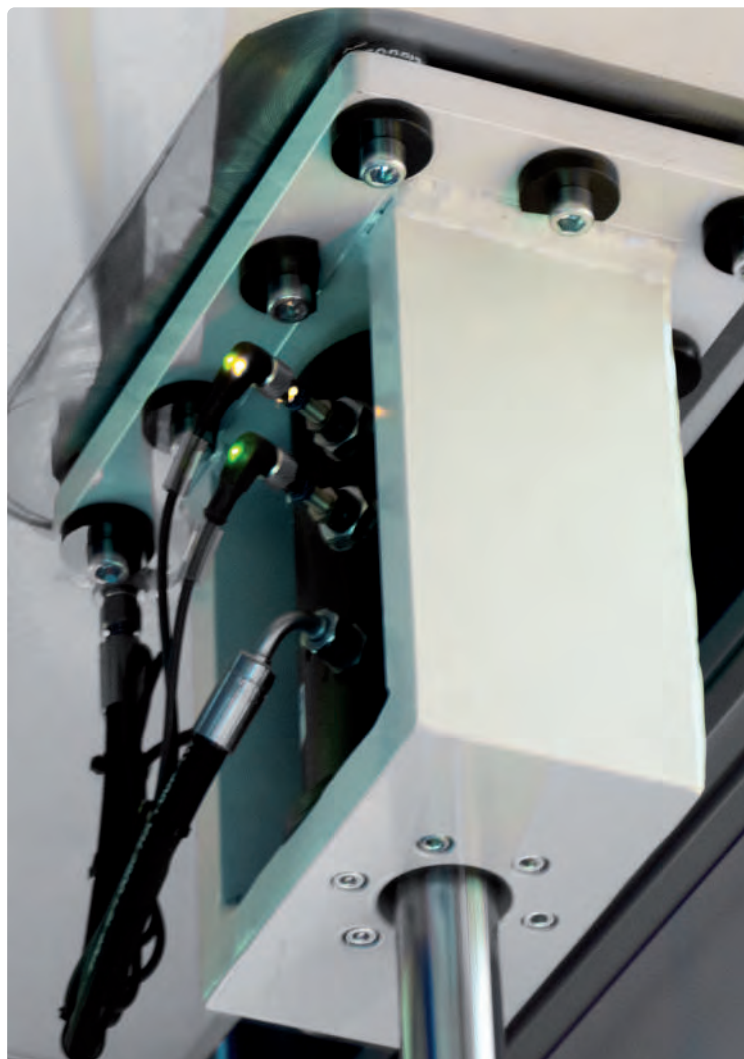

I

PIANO SUPERIORE DELLA PRESSA RIBALTABILE FRONTALMENTE DI 100°

Per un accesso ottimale allo stampo, il piano superiore della pressa può essere ribaltato frontalmente di 100°. Ribaltando il piano della macchina sul lato corto, l'operatore può lavorare a un'altezza ottimale, stando normalmente in piedi, senza dover ricorrere a instabili scale, pedane o apparecchiature di sollevamento, spesso necessarie nel caso di presse in cui viene ruotato il lato lungo. Inoltre con il ribaltamento sul lato corto, l'altezza complessiva della pressa è nettamente ridotta.

D

OBERER PRESENTISCH UM 100° NACH VORNE SCHWENKBAR

Für eine optimale Zugänglichkeit des Werkzeuges kann der obere Pressentisch um 100° nach vorne gekippt werden. Durch das Kippen des Maschinentisches über die schmale Seite kann der Maschinenbediener in einer optimalen Höhe, beim normalen Stehen arbeiten, ohne auf un stabile Leitern, Trittbretter oder Hebemittel angewiesen zu sein, die oft bei Pressen notwendig sind, bei denen die lange Seite ausgeschwenkt wird. Außerdem wird beim Kippen über die schmale Seite, die Gesamthöhe der Presse deutlich reduziert.

EN

PRESS UPPER PLATE TILTING FORWARD BY 100°

For optimal access to the mould, the press upper plate can be tilted forward by 100°. By tilting the press plate on the short side, the operator can work at an optimal height, normally standing, without having to use instable ladders, platforms or lifting equipment, which are often necessary when operating presses with long side rotation. Moreover, by tilting on the short side, the overall press height is considerably shortened.

F

PLATEAU SUPERIEUR DE LA PRESSE BASCULANT EN AVANT DE 100°

Pour un accès optimal au moule, le plateau supérieur de la presse peut être basculé en avant de 100°. En basculant le plateau de la machine sur le côté court, l'opérateur peut travailler à une hauteur optimale, normalement debout, sans devoir recourir à d'instables échelles, plateformes ou équipements de levage, souvent nécessaires en cas de presses dans lesquelles on tourne le côté long. En outre, avec le basculement sur le côté court, l'hauteur totale de la presse est nettement réduite.

I QUESTO SIGNIFICA UNA POSIZIONE DI LAVORO VANTAGGIOSA CON, AL CONTEMPO, MASSIMA SICUREZZA DI LAVORO

D DIES BEDEUTET, EINE VORTEILHAFTE ARBEITSPOSITION BEI GLEICHZEITIG MAXIMALER ARBEITSSICHERHEIT

EN THIS MEANS AN ADVANTAGEOUS WORKING POSITION, AND AT THE SAME TIME THE UTMOST SAFETY AT WORK

F CELA SIGNIFIE UNE POSITION DE TRAVAIL AVANTAGEUSE AVEC, EN MEME TEMPS, LA SECURITE DE TRAVAIL MAXIMALE



I

PIANO SUPERIORE DELLA PRESSA RIBALTABILE DI 150°

Per versioni a pavimento. Durante la prima fase il piano superiore della pressa viene ribaltato fino a 100°.

Successivamente, tramite il movimento di discesa, il piano della pressa si appoggia e scorre sulle 2 mensole sagomate fino alla posizione finale di ~150°.

E' possibile fermarsi in tutte le posizioni intermedie. Dopo la completa chiusura, il piano della pressa è automaticamente centrato con alta precisione e bloccato da un sistema azionato tramite cilindri idraulici.

I

OTTIMALE ACCESSIBILITÀ ALLO STAMPO, SENZA DOVERSI PIEGARE, CON MASSIMA COMODITÀ E SICUREZZA

D

BESTE ZUGÄNLICHKEIT ZUM WERKZEUG, OHNE SICH ZU BEUGEN, MIT HÖCHSTER BEQUEMLICHKEIT UND SICHERHEIT

EN

OPTIMAL ACCESS TO THE MOULD, WITH NO NEED TO BEND, MAXIMUM COMFORT AND SAFETY

F

ACCESSIBILITE OPTIMALE AU MOULE, SANS DEVOIR SE PLIER, AVEC LE CONFORT ET LA SECURITE MAXIMAL(E)

D

OBERER PRESSENTISCH UM 150° SCHWENKBAR

Nur bei Bodenversion. Im ersten Schritt schwenkt der obere Pressentisch bis auf 100°. Beim nachfolgenden Abstiegsbewegungsablauf wird der Pressentisch auf den 2 profilierten Konsolen bis zur ~150°-Endposition gerollt.

Jede Zwischenposition ist möglich. Nach dem vollständigen Einschwenken wird der Pressentisch automatisch mit hoher Präzision durch ein System zentriert und sicher verriegelt, das durch hydraulische Zylinder angetrieben wird.

EN

PRESS UPPER PLATE TILTING BY 150°

For the versions installed on the floor only. During the first phase the press upper plate is tilted by up to 100°.

After that, with the down stroke movement, the press plate leans and slides on the 2 shaped brackets up to the final ~150° position. It is possible to stop in all intermediate positions. After complete closure, the press plate is automatically centred with high precision and locked by a system driven by hydraulic cylinders.

F

PLATEAU SUPERIEUR DE LA PRESSE BASCULANT DE 150°

Seulement pour les versions installées au sol. Pendant la première phase, le plateau supérieur de la presse est basculé jusqu'à 100°. Ensuite, avec le mouvement de descente, le plateau de la presse s'appuie et glisse sur les 2 consoles profilées jusqu'à la position finale de ~150°.

Il est possible de s'arrêter dans toutes les positions intermédiaires. Après la fermeture complète, le plateau de la presse est automatiquement centré avec haute précision et verrouillé par un système entraîné par des cylindres hydrauliques.



I

PIANO SUPERIORE DELLA MACCHINA RIBALTABILE DI 180° PARALLELO AL PAVIMENTO VERSIONE IN FOSSA

Durante la prima fase il piano superiore della pressa viene ribaltato fino a 100°. Successivamente, tramite il movimento di discesa, il piano della pressa si appoggia e scorre sulle 2 mensole sagomate fino alla posizione finale di 180°/parallelo. E' possibile fermarsi in tutte le posizioni intermedie. Dopo la completa chiusura, il piano della pressa è automaticamente centrato con alta precisione e bloccato da un sistema azionato tramite cilindri idraulici.

D

KIPPEN DES OBERTISCHES UM 180° VERSENKTE AUSFÜHRUNG (PARALLEL ZUM BODEN)

Im ersten Schritt schwenkt der obere Pressentisch bis auf 100°. Beim nachfolgenden Abstiegsbewegungsablauf wird der Pressentisch auf den 2 profilierten Konsolen bis zur 180° / waagrechten Endposition gerollt. Jede Zwischenposition ist möglich. Nach dem vollständigen Einschwenken wird der Pressentisch automatisch mit hoher Präzision durch ein System zentriert und verriegelt, das durch hydraulische Zylinder angetrieben wird.

EN

PRESS UPPER PLATE TILTING BY 180° PARALLEL TO THE FLOOR, UNDERFLOOR VERSION

During the first phase, the press upper plate is tilted by up to 100°. After that, with the down stroke movement, the press plate leans and slides on the 2 shaped brackets up to the final 180° / horizontal position. It is possible to stop in all intermediate positions. After complete closure, the press plate is automatically centred with high precision and locked by a system driven by hydraulic cylinders.

F

PLATEAU SUPERIEUR DE LA MACHINE BASCULANT DE 180° PARALLELE AU SOL VERSION EN FOSSA

Pendant la première phase, le plateau supérieur de la presse est basculé jusqu'à 100°. Ensuite, avec le mouvement de descente, le plateau de la presse s'appuie et glisse sur les 2 consoles profilées jusqu'à la position finale de 180° / horizontale. Il est possible de s'arrêter dans toutes les positions intermédiaires. Après la fermeture complète, le plateau de la presse est automatiquement centré avec haute précision et verrouillé par un système entraîné par des cylindres hydrauliques.

I

IL VANTAGGIO DELL'UTILIZZO DEL PIANO RIBALTABILE FINO A 180° (CONSIGLIABILE PER LE VERSIONI IN FOSSA) CONSISTE NELL'AGEVOLARE IL LAVORO DI MONTAGGIO E SMONTAGGIO DI INSERTI, SLITTE E CILINDRI IDRAULICI, NONCHÉ NELL'OTTIMALE ACCESSIBILITÀ ALL'INTERO PIANO DELLA PRESSA

D

DER VORTEIL, BEIM EINSATZ DES 180° KIPPTISCHES (EMPFEHLENSWERT FÜR DIE VERSENKTE AUSFÜHRUNG), LIEGT IN DER EINFACHEN MONTAGE UND DEMONTAGE VON EINSÄTZEN, SCHIEBERN UND KERNZÜGEN, SOWIE IN DER OPTIMALEN ZUGÄNGLICHKEIT DES GESAMTEN PRESENTISCHES

EN

THE ADVANTAGE OFFERED BY THE USE OF THE 180° TILTING PLATE (RECOMMENDED FOR THE UNDERFLOOR VERSIONS) IS EASY ASSEMBLY AND DISASSEMBLY OF INSERTS, SLIDES AND HYDRAULIC CYLINDERS, AS WELL AS AN OPTIMAL ACCESS TO THE WHOLE PRESS PLATE

F

L'AVANTAGE DE L'UTILISATION DU PLATEAU BASCULANT JUSQU'A 180° (CONSEILLE POUR LES VERSIONS EN FOSSA) EST LA FACILITATION DU TRAVAIL DE MONTAGE ET DEMONTAGE D'INSERTS, COULISSES ET CYLINDRES HYDRAULIQUES, AINSI QUE L'ACCESSIBILITE OPTIMALE A L'ENTIER PLATEAU DE LA PRESSE



I

RIBALTAMENTO DEL PIANO INFERIORE DELLA PRESSA DI $\pm 70^\circ$ LATO ANTERIORE / POSTERIORE

Solo per le versioni CLASSIC installate a pavimento. Grazie a 2 cilindri idraulici il piano inferiore può essere ribaltato fino a $\sim 70^\circ$ sul lato anteriore e posteriore per portare lo stampo in una posizione ergonomica. I movimenti di ribaltamento (e bloccaggi automatici) sono comandati tramite il TOUCH PANEL.

D

KIPPEN DES UNTEREN PRESENTISCHES UM $\pm 70^\circ$ NACH VORNE / HINTEN

Nur bei CLASSIC Bodenversion. Über 2 Hydraulikzylinder kann der untere Tisch um 70° nach vorne und nach hinten geschwenkt werden, um das Werkzeug in eine ergonomische Position zu bringen. Die Schwenkbewegungen (und automatische Verriegelungen) werden über das TOUCH PANEL ausgelöst.

EN

LOWER PLATE TILTING BY $\pm 70^\circ$, FRONT / BACK SIDE

For the CLASSIC versions installed on the floor only. Thanks to 2 hydraulic cylinders, the lower plate can be tilted up to 70° , on the front and back side, to bring the mould to an ergonomically better position. Tilting movements (and automatic locking) are controlled by means of the TOUCH PANEL.

I

OTTIMALE ACCESSIBILITÀ ALLO STAMPO, SENZA DOVERSI PIEGARE, CON MASSIMA COMODITÀ E SICUREZZA

D

BESTE ZUGÄNGLICHKEIT ZUM WERKZEUG, OHNE SICH ZU BEUGEN, MIT HÖCHSTER BEQUEMLICHKEIT UND SICHERHEIT.

EN

OPTIMAL ACCESS TO THE MOULD, WITH NO NEED TO BEND, MAXIMUM COMFORT AND SAFETY

F

ACCESSIBILITE OPTIMALE AU MOULE, SANS DEVOIR SE PLIER, AVEC LE CONFORT ET LA SECURITE MAXIMALE

F

BASCULEMENT DU PLATEAU INFERIEUR DE LA PRESSE DE $\pm 70^\circ$ EN AVANT/ARRIERE

Seulement pour les versions CLASSIC installées au sol. Grâce à 2 cylindres hydrauliques, le plateau inférieur peut être basculé jusqu'à $\sim 70^\circ$, en avant et en arrière, pour mettre le moule dans une position plus ergonomique. Les mouvements de basculement (et verrouillages automatiques) sont commandés au moyen du TOUCH PANEL.

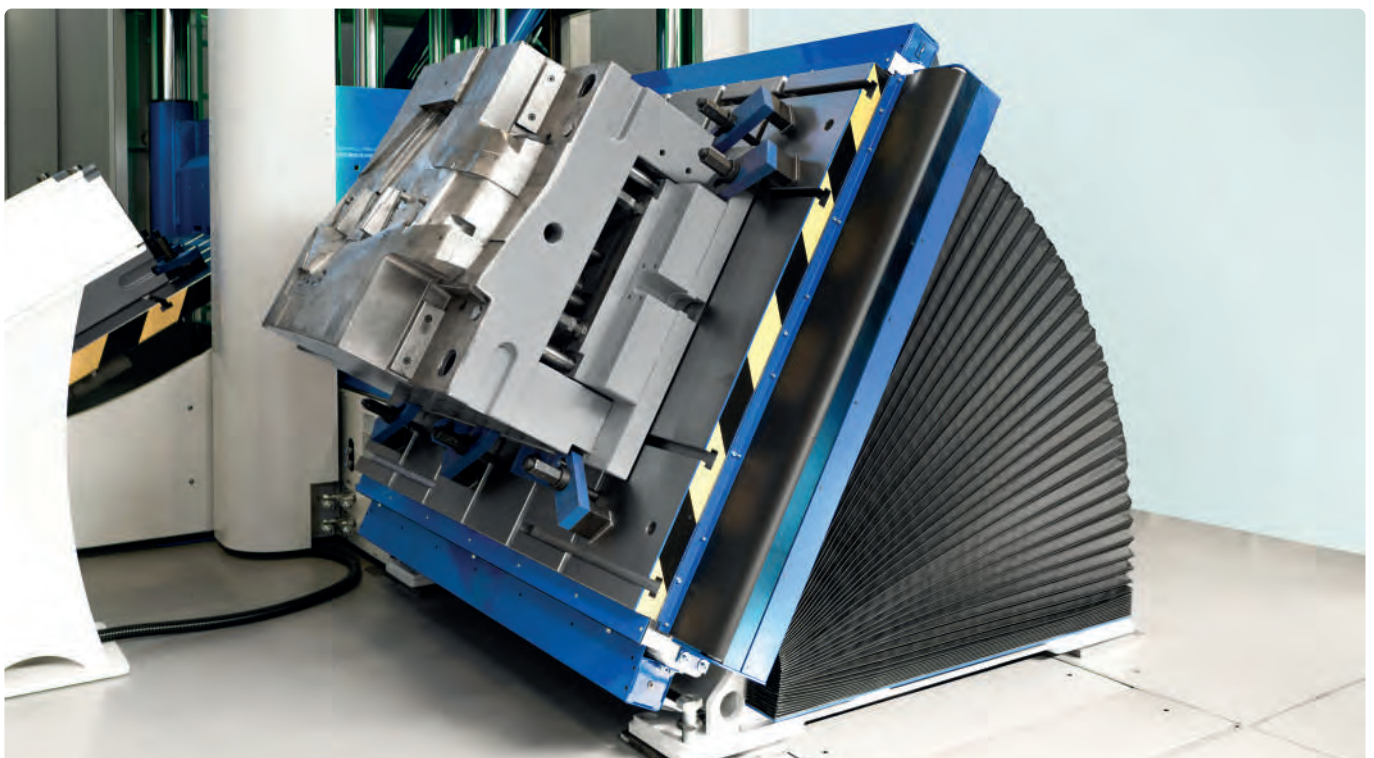

I
**PIANO ESTRAIBILE CON TAVOLA
 ROTANTE 0°-180° INTEGRATA
 PER STAMPI MULTICOMPONENTI**

Per l'aggiustaggio di stampi multicomponente o multicolore, la tavola rotante è completamente integrata nel piano inferiore della macchina. Il comando è eseguito comodamente dal TOUCH PANEL. La rotazione del piano della pressa è possibile nella posizione di 0° o 180°. Dopo la rotazione nelle due posizioni finali, la tavola rotante è posizionata e fissata per mezzo di un cilindro idraulico.

D
**AUSZIEHTISCH MIT INTEGRIERTEM
 DREHTELLER 0°-180° FÜR
 MEHRKOMPONENTEN- WERKZEUGE**

Für die Anpassung von Mehrkomponenten- oder Mehrfarbenwerkzeugen wird im unteren Maschinentisch ein Drehteller integriert. Die gesamte Bedienung erfolgt bequem über das TOUCH PANEL. Die Drehung des Pressentisches ist in der 0° oder 180° Stellung möglich. Nach dem Drehen in die beiden Endpositionen wird der Drehteller positioniert und über einen Hydraulikzylinder fixiert.

EN
**EXTENSIBLE PLATE WITH
 INTEGRATED 0°-180° ROTATING TABLE
 FOR MULTICOMPONENT MOULDS**

For the fitting of multicomponent or multicolour moulds, the rotating table is fully integrated in the press lower plate. Control is comfortably performed from the TOUCH PANEL. The press plate rotation is possible either in the 0° or in the 180° position. After rotation into the two final positions, the rotating table is positioned and locked by means of a hydraulic cylinder.

I L'IMPIEGO DELLA TAVOLA ROTANTE INTEGRATA GARANTISCE MAGGIORE PRECISIONE ED EVITA COMPLETAMENTE LA ROTAZIONE MANUALE DELLO STAMPO PER LA SUA PROVA, LA QUALE RICHIEDE MOLTO TEMPO

D DURCH DEN EINSATZ DES INTEGRIERTEN DREHTELLERS WIRD DAS ZEITAUFWENDIGE, MANUELLE DREHEN DES WERKZEUGES BEIM TUSCHIEREN KOMPLETT EINGESPART UND EINE HÖHERE PRÄZISION GARANTIERT

EN THE USE OF THE INTEGRATED ROTATING TABLE GUARANTEES GREATER ACCURACY AND COMPLETELY OBIVIATES THE MANUAL ROTATION OF THE MOULD FOR ITS SPOTTING, SAVING A LOT OF TIME

F L'EMPLOI DE LA TABLE ROTATIVE INTEGREE GARANTIT UNE PLUS HAUTE PRECISION ET EMPECHE COMPLETEMENT LA ROTATION MANUELLE DU MOULE POUR SON ESSAI, QUI PREND BEAUCOUP DE TEMPS

F
**PLATEAU EXTRACTIONNEL AVEC TABLE
 ROTATIVE 0-180° INTEGREE POUR
 MULTICOMPONENT MOULES**

Pour l'ajustage de multicomponent moules ou multicolore, la table rotative est complètement intégrée dans le plateau inférieur de la machine. La commande est exécutée confortablement du TOUCH PANEL. La rotation du plateau de la presse est possible dans la position de 0° ou 180°. Après la rotation dans les deux positions finales, la table rotative est positionnée et fixée par un cylindre hydraulique.

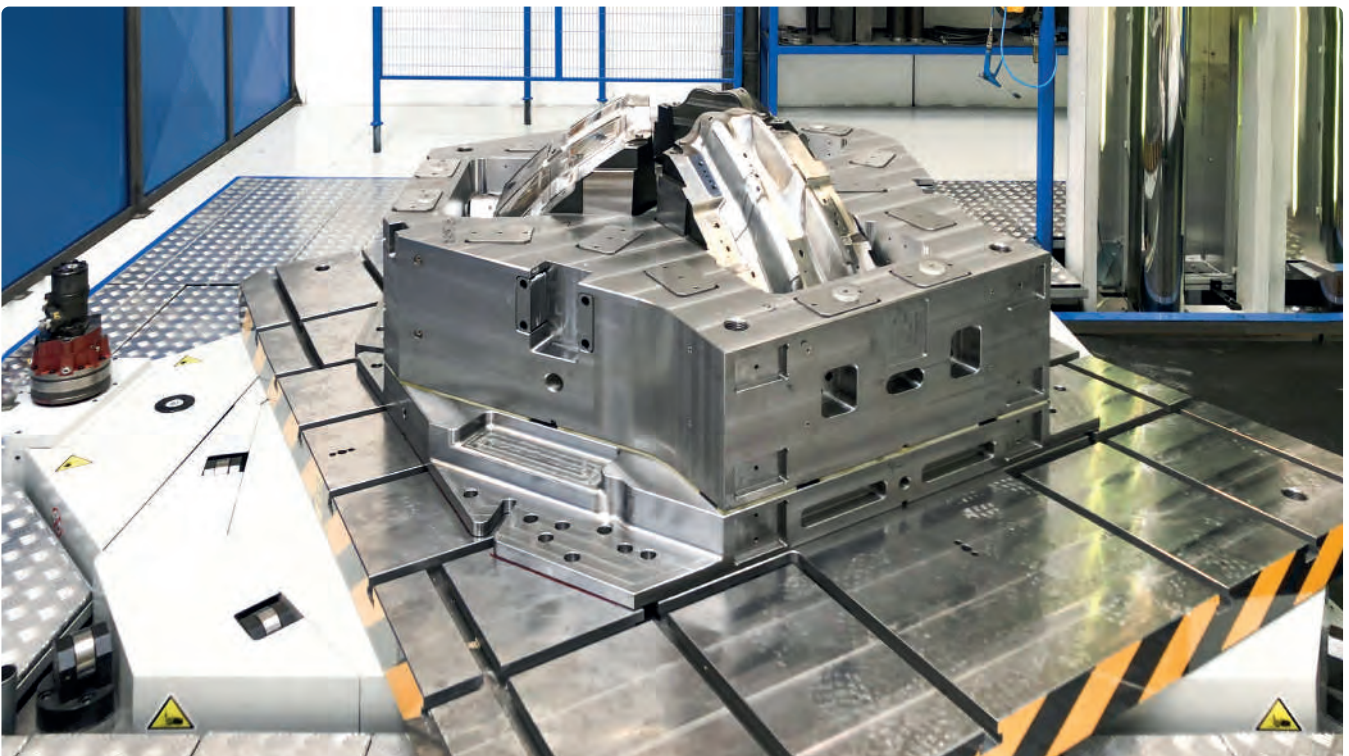

I

CONTROLLO ELETTRONICO DEL PARALLELISMO DEL PIANO SUPERIORE

Il sistema di controllo è composto da 4 dispositivi elettronici di misura (Encoder) che verificano in modo continuo la posizione e il parallelismo del piano superiore della pressa rispetto al piano inferiore e sono disposti diagonalmente ai quattro angoli esterni del piano superiore in corrispondenza delle colonne. I valori misurati vengono visualizzati dinamicamente sul TOUCH PANEL per l'intera corsa. In caso di superamento dei parametri limite prestabiliti, il movimento di chiusura della mazza viene immediatamente disattivato e l'errore è visualizzato sul display. Tale superamento può aver luogo per esempio a causa di slitte o cilindri idraulici non retratti, oppure di utensili dimenticati nello stampo (raschietti, molatrici, blocchetti di riscontro, martelli ecc.).

D

ELEKTRONISCHE PARALLELISMUSKONTROLLE DES OBEREN MASCHINENTISCHES

Das Kontrollsystem besteht aus 4 elektronischen Messsystemen (Encoder). Diese überprüfen permanent die Position und Parallelität des oberen Pressentisches zum unteren Pressentisch und sind diagonal an den vier Außenecken des Obertisches an den Säulen angebracht. Die gemessenen Werte werden dynamisch über den gesamten Hub auf dem TOUCH PANEL angezeigt. Bei Überschreitung der vorgegebenen Grenzwerte wird die Stößelschließbewegung sofort abgeschaltet und der Fehler wird im Display angezeigt. Diese Überschreitung kann z. Bsp. durch nicht zurückgezogene Schieber oder Kernzüge, oder in der Form vergessene Werkzeuge (Schaber, Schleifgeräte, Endmaße, Hammer, usw.) entstehen.

EN

ELECTRONIC UPPER PLATE PARALLELISM CONTROL

The control system includes 4 electronic measurement devices (encoders) located diagonally in the four external corners near the columns, which continuously check the press upper plate position parallel to the lower plate. The measured values are dynamically displayed on the TOUCH PANEL for the entire stroke. If the preset limit parameters are exceeded, the ram closing movement is immediately disabled and the error is shown on the display. Parameters can be exceeded for example because of slides or hydraulic cylinders not retracted, or tools forgotten in the mould (scrapers, grinders, slip gauges, hammers etc.)

F

CONTROLE ELECTRONIQUE DU PARALLELISME DU PLATEAU SUPERIEUR

Le système de contrôle comprend 4 dispositifs électroniques de mesure (Encoders) qui vérifient de façon continue la position et le parallélisme du plateau supérieur de la presse par rapport au plateau inférieur, arrangés diagonalement aux quatre angles externes du plateau supérieur à la hauteur des colonnes. Les valeurs mesurées sont affichées dynamiquement sur le TOUCH PANEL pour la course entière. En cas de dépassement des paramètres limite préétablis, le mouvement de fermeture du coulisseau est immédiatement désactivé et l'erreur est visualisée sur le TOUCH PANEL. Ce dépassement peut avoir lieu par exemple à cause de coulisses ou cylindres hydrauliques non rentrés, ou d'outils oubliés dans le moule (racleurs, meuleuses, cales rectangulaires, marteaux etc.).

I

CON L'IMPIEGO DI QUESTO SISTEMA SI PROTEGGE DALL'EVENTUALE DANNEGGIAMENTO SIA LA PRESSA CHE GLI STAMPI STESSI

D

DURCH DEN EINSATZ DIESES SYSTEMS WERDEN SOWOHL DIE TUSCHIERPRESSE, ALS AUCH DIE WERKZEUGE UND FORMEN VOR BESCHÄDIGUNGEN GESCHÜTZT

EN

USING THIS SYSTEM BOTH THE PRESS AND MOULDS ARE PROTECTED FROM POSSIBLE DAMAGE

F

AVEC L'EMPLOI DE CE SYSTEME ON PROTEGE DE L'ENDOMMAGEMENT EVENTUEL TANT LA PRESSE QUE LES MOULES

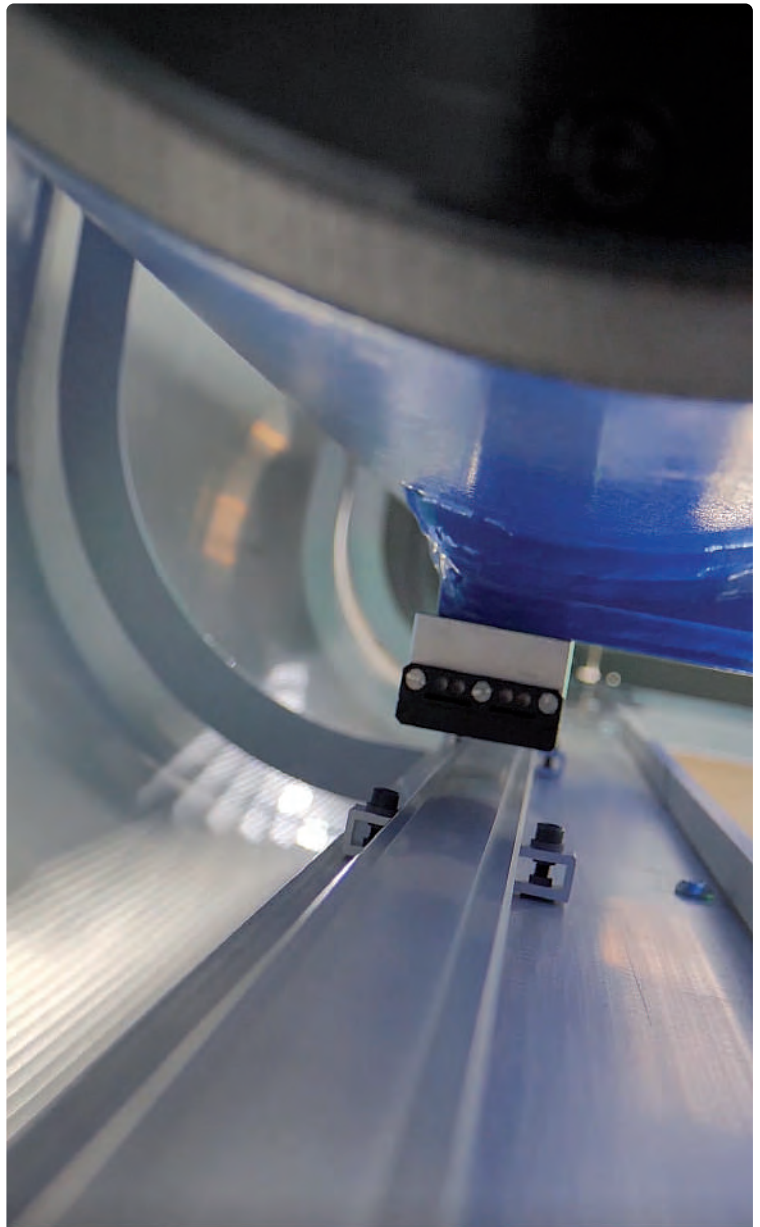

I

ACCUMULATORE DI ENERGIA (A COLPO ISTANTANEO) - BREVETTATO

Per la messa a punto di stampi per materie plastiche, gomma e pressofusione.

È un dispositivo idraulico che viene fissato al piano superiore della pressa. Esso permette di dare un colpo istantaneo sullo stampo chiuso per poter meglio verificare l'accoppiamento fra i due semistampi (matrice e punzone). L'azione dinamica del dispositivo è indipendente dal movimento di chiusura della pressa. Di conseguenza, alla forza di chiusura della pressa si aggiunge l'effetto dinamico dell'accumulatore di energia.

D

ENERGIESPEICHER (SCHLAGAUSLÖSER) - PATENTIERT

Dieser dient zur Einstellung von Kunststoff- Gummi- und Druckgussformen. Es handelt sich um eine hydraulische Vorrichtung, welche am Obertisch der Presse befestigt wird. Diese erlaubt einen unmittelbaren heftigen Schlag auf die geschlossene Form, um somit die Anpassung zwischen den beiden Formhälften (Stempel und Matrize) besser kontrollieren zu können. Die dynamische Wirkung dieser Vorrichtung ist von der Schliessbewegung der Presse unabhängig. Daher addiert sich der Schliesskraft der Presse die dynamische Wirkung des Energiespeichers hinzu.

EN

ENERGY ACCUMULATOR (SINGLE SHOT) - PATENTED

This operation sets up dies and moulds for plastic materials, rubber and die casting.

It is a hydraulic device that should be fixed to the press upper plate. It allows to strike a shot on the closed mould, in order to better gauge the adjustment between the two mould halves (matrix and punch). The dynamic action of this device is independent from the press clamping movement.

As a result, the dynamic action of the energy accumulator will add to the press clamping force.

F

ACCUMULATEUR D'ENERGIE (A COUP INSTANTANE) - BREVETE

Pour la mise au point des moules pour les matières plastiques, la gomme et la coulée sous pression des métaux. Ce dispositif hydraulique doit être fixé sur le plateau supérieur de la presse. Il permet de frapper un coup sur le moule fermé pour mieux vérifier l'accouplement entre les deux demi-moules (matrices et poinçons). L'action dynamique du dispositif est indépendante du mouvement de fermeture de la presse. Par conséquent, cet effet dynamique de l'accumulateur d'énergie s'ajoutera à la force de fermeture de la presse.

I

AUMENTA L'EFFICIENZA DELLA MARCATURA DEL BLU DI PRUSSIA

D

STEIGERT DIE EFFIZIENZ DER MARKIERUNG DER BLAUEN TUSCHIERFARBE

EN

INCREASES THE EFFICIENCY OF THE PRUSSIAN BLUE MARKING

F

IL AUGMENTE L'EFFICIENCE DU MARQUAGE AU BLEU DE PRUSSE

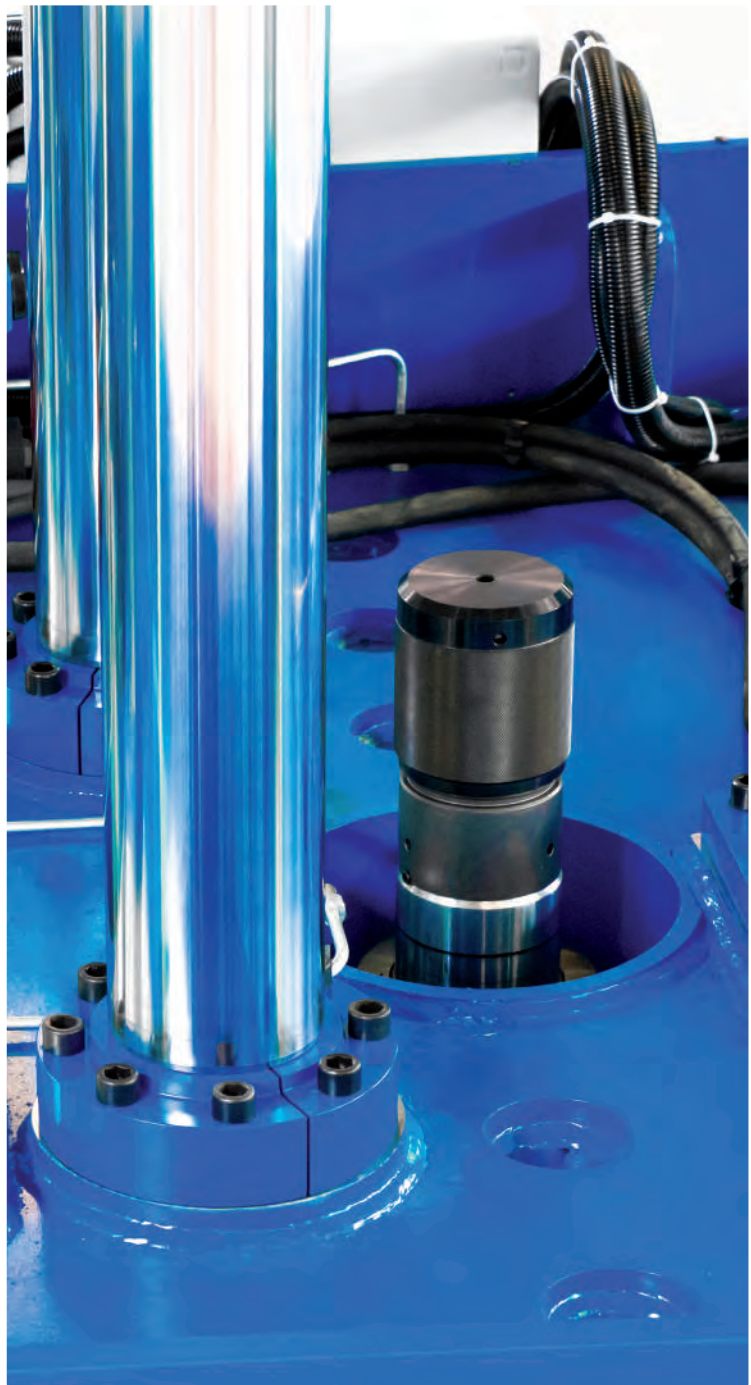

E01

I

Particolari stampati con il gruppo iniettore cera

D

Mit der Wachseinspritzeinheit gegossene Teile

EN

Items moulded with the special wax injection unit

F

Pièces moulées avec le groupe d'injection de résine

I

VERIFICA FINALE DEL PEZZO OTTENUTO TRAMITE INIEZIONE A BASSA PRESSIONE

D

ABSCHLIESSENDE ÜBERPRÜFUNG DES PRODUKTES DURCH EINE NIEDRIGDRUCKEINSPRITZUNG

EN

FINAL CHECKING OF THE PIECE OBTAINED THROUGH LOW PRESSURE INJECTION

F

VÉRIFICATION FINALE DE LA PIÈCE OBTENUE PAR INJECTION À BASSE PRESSION



I UNITÀ AUTOMATICA D'INIEZIONE DI CERE SPECIALI - Esso consente l'iniezione nello stampo a bassa pressione di cere speciali. Si possono così controllare, in base ai pezzi stampati ottenuti, dimensioni e spessori, grado di tenuta dello stampo, eventuali bave e scorrimento del materiale. Il gruppo iniettore cera è composto di: contenitore cera con riscaldamento elettrico termoregolato, azionamento pneumatico con regolazione di pressione, sistema di controllo temperatura della camera per il costante grado di scorrimento del materiale.

DATI TECNICI	MIL 122	MIL 123	MIL 142	MIL 143	MIL 162	MIL 163	MIL 202	MIL 203
Capacità dell'iniettore		3				15		
Temperatura regolabile con termostato		50 a 200°C				50 a 200°C		
Pressione pneumatica dell'esercizio		6 bar [kg/cm ²]				6 bar [kg/cm ²]		
MATERIALE DA INIETTARE								
CR - 24 rigida		-				-		
Punto di fusione		ca. 90°C				ca. 90°C		
Temperatura d'iniezione		ca. 140°C				ca. 140°C		
Ritiro		0,6 %				0,6 %		
Rifusione		ca. 4 volte				ca. 4 volte		

D AUTOMATISCHE SPEZIALWACHS-EINSPRITZEINHEIT - Die Wachs-Einspritzeinheit ermöglicht durch Niederdruck die Einspritzung von Spezialwachsen in die Formen. Anhand der daraus gewonnenen Teile können die Abmessungen und der Dichtheitsgrad der Form, der Gleitgrad des Materials, sowie eventuelle Formfugen überprüft werden. Die Wachs-Einspritzeinheit besteht aus: einem elektrisch geheizten Wachsbehälter mit Temperaturregelung, einem pneumatischen Antrieb mit Druckregulierung, einer Temperaturregulierung der Druckkammer zur Erhaltung eines gleichbleibenden Materialgleitgrades.

TECHNISCHE DATEN	MIL 122	MIL 123	MIL 142	MIL 143	MIL 162	MIL 163	MIL 202	MIL 203
Fassungsvermögen, in Liter		3				15		
Temperaturregulierung durch Thermostat		50 a 200°C				50 a 200°C		
Druckluft-Betriebsdruck		6 bar [kg/cm ²]				6 bar [kg/cm ²]		
EINSPRITZMATERIAL								
Wachs CR - 24 starr		-				-		
Schmelzpunkt		ca. 90°C				ca. 90°C		
Einspritztemperatur		ca. 140°C				ca. 140°C		
Schwindung		0,6 %				0,6 %		
Wiederverwendung		ca. 4 mal				ca. 4 mal		

EN SPECIAL WAX AUTOMATIC INJECTION UNIT - This attachment provides a way to inject special wax at a low pressure into the mould cavity. This enables the mould maker to check – based on the moulded pieces obtained - dimensions and thicknesses, mould leak-tightness, possible flashes and creep of the material. The wax injection attachment includes: wax container with electric heating and temperature control, pneumatic drive with pressure control, and temperature control of the chamber to attain constant wax fluidity.

TECHNICAL DATA	MIL 122	MIL 123	MIL 142	MIL 143	MIL 162	MIL 163	MIL 202	MIL 203
Wax container capacity, Litre		3				15		
Temperature control with thermostat		50 a 200°C				50 a 200°C		
Working air pressure		6 bar [kg/cm ²]				6 bar [kg/cm ²]		
MATERIAL FOR INJECTION								
Wax CR - 24 rigid		-				-		
Melting point		about 90°C				about 90°C		
Injection temperature		about 140°C				about 140°C		
Shrinkage		0,6 %				0,6 %		
Recycling		about 4 times max				about 4 times max		

F UNITE AUTOMATIQUE D'INJECTION DE CIRE - Le groupe injecteur a été conçu pour l'injection à basse pression de cires spéciales dans le moule. On peut ainsi vérifier les dimensions et épaisseurs des pièces moulées, la précision des surfaces de fermeture du moule, les bavures éventuelles et le fluage. Le groupe injecteur est constitué par: un réservoir pour résine à chauffage électrique avec réglage thermique, commande pneumatique avec réglage de pression, un contrôle de la température du réservoir pour assurer la fluidité de la cire.

DONNEES TECHNIQUES	MIL 122	MIL 123	MIL 142	MIL 143	MIL 162	MIL 163	MIL 202	MIL 203
Injecteur cire: capacité Litres		3				15		
Température réglable avec thermostat		50 à 200°C				50 à 200°C		
Pression commande pneumatique		6 bar [kg/cm ²]				6 bar [kg/cm ²]		
MATIÈRE A INJECTER								
Cire CR - 24 rigide		-				-		
Point fusion		ca. 90°C				ca. 90°C		
Injection à		ca. 140°C				ca. 140°C		
Retrait		0,6 %				0,6 %		
Refonte		env. 4 fois				env. 4 fois		

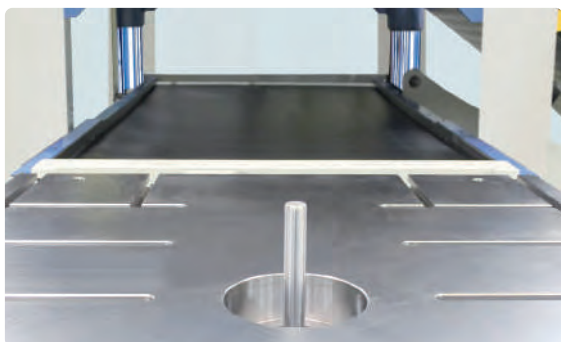

- I** VERIFICA DINAMICA DEGLI ELEMENTI ESTRATTORI
- D** DYNAMISCHE ÜBERPRÜFUNG DER AUSWERFERELEMENTE
- EN** DYNAMIC CHECKING OF THE EJECTION ELEMENTS
- F** VERIFICATION DYNAMIQUE DES ELEMENTS EXTRACTEURS

I UNITÀ ESPULSORE IDRAULICO

Consente di azionare il movimento del tavolino di estrazione degli stampi per materie plastiche e pressofusione.

DATI TECNICI	MIL122 MIL123 MIL142 MIL143	MIL162 MIL163	MIL202 MIL203	MIL252 MIL253 MIL262 MIL263	MIL302 MIL303 MIL304 MIL305	MIL306 MIL307 MIL408	MIL2015 MIL2520 MIL3020 MIL3025	MIL3525 MIL3030 MIL3530 MIL4030
Forza espulsione max., kN	45	70	100	100	100	100	100	100
Corsa dell'espulsore mm	100	130	240	250	250	250	250	250

D HYDRAULISCHE AUSWERFEREINHEIT

Die Ausstoss-Einheit erlaubt die Inbetriebsetzung der Auswurfplatte für die Kunststoff-und Spritzgussformen.

TECHNISCHE DATEN	MIL122 MIL123 MIL142 MIL143	MIL162 MIL163	MIL202 MIL203	MIL252 MIL253 MIL262 MIL263	MIL302 MIL303 MIL304 MIL305	MIL306 MIL307 MIL408	MIL2015 MIL2520 MIL3020 MIL3025	MIL3525 MIL3030 MIL3530 MIL4030
Max. Auswerferkraft, kN	45	70	100	100	100	100	100	100
Hub des Auswerfers mm	100	130	240	250	250	250	250	250

EN HYDRAULIC EJECTOR UNIT

The ejection unit initiates the movement of the ejection pins of die and moulds for plastic materials and die casting.

TECHNICAL DATA	MIL122 MIL123 MIL142 MIL143	MIL162 MIL163	MIL202 MIL203	MIL252 MIL253 MIL262 MIL263	MIL302 MIL303 MIL304 MIL305	MIL306 MIL307 MIL408	MIL2015 MIL2520 MIL3020 MIL3025	MIL3525 MIL3030 MIL3530 MIL4030
Max ejection force, kN	45	70	100	100	100	100	100	100
Ejector stroke mm	100	130	240	250	250	250	250	250

F UNITE EJECTEUR HYDRAULIQUE

Pour actionner les éjecteurs et vérifier la course des plaques d'éjection des moules pour matières plastiques et pour coulées sous pression

DONNEES TECHNIQUES	MIL122 MIL123 MIL142 MIL143	MIL162 MIL163	MIL202 MIL203	MIL252 MIL253 MIL262 MIL263	MIL302 MIL303 MIL304 MIL305	MIL306 MIL307 MIL408	MIL2015 MIL2520 MIL3020 MIL3025	MIL3525 MIL3030 MIL3530 MIL4030
Force d'éjection max., kN	45	70	100	100	100	100	100	100
Course éjecteur mm	100	130	240	250	250	250	250	250



I ADATTO ALLA GESTIONE DI NUMEROSI CILINDRI AUSILIARI E PER LE PRESSE INSTALLATE NELLE VERSIONI IN FOSSE

D GEEIGNET FÜR DIE VERWALTUNG VON ZAHLREICHEN KERNZÜGEN UND FÜR DIE VERSENKTE AUSFÜHRUNG

EN SUITABLE FOR THE MANAGEMENT OF MANY AUXILIARY CYLINDERS AND FOR THE PRESS PIT VERSIONS

F INDIQUE POUR LA GESTION DE PLUSIEURS CYLINDRES AUXILIAIRES ET POUR LES PRESSES DES VERSIONS EN FOSSE

I CARRELLO PER CILINDRI AUSILIARI IDRAULICI (4+4)
E' composto da una centrale idraulica indipendente interfacciata alla pressa disponibile con pompe da 8 e 40 litri/min. e versioni specifiche per acqua-glicole.

D ROLLWAGEN FÜR KERNZÜGE (4+4)
Er besteht aus einem selbstständigen Hydraulikaggregat, das mit der Presse verbunden ist. Er kann mit einer Pumpe mit Förderleistung in Höhe von 8 oder 40 Litern/Min. und in Sonderausführungen spezifisch für Wasser-Glykol-Anwendungen geliefert werden.

EN AUXILIARY CYLINDER HYDRAULIC TRUCK (4+4)
It includes a standalone hydraulic power unit interfaced to the press, available with pumps delivering 8 and 40 litres/min, as well as special versions for water-glycol applications.

F CHARIOT HYDRAULIQUE POUR VERINS (4+4)
Il se compose d'un groupe idraulique indépendant interfacé avec la presse, disponible avec pompe de 8 ou 40 litres/min. et en version spécifique pour les applications eau-glycol.

DISCOVER 10 GOOD REASONS TO INVESTING IN A MILLUTENSIL'S MOULD AND DIE SPOTTING PRESS

■ There are many fundamental advantages by choosing our spotting presses.



Advanced electronic control of the upper plate parallelism through linear magnetic encoders

Moulds retain **higher quality** and **longer service life**

Improved safety of both on-site personnel and the mould itself

Optimal accessibility and ergonomics by means of tilting the upper/lower platens as well as lower platen with integrated table for multi-component moulds

More precision

More safety

Better ergonomics and design

Value of the brand

Modern diagnostic system

Reliable **remote assistance and diagnostic system**

Millutensil has developed **automatic functional tests** in order to simulate production during the spotting phase

Special cycles for simulating production

Thanks to the **SIEMENS Tablet with integrated camera and My Mill®** (dedicated copyrighted Millutensil software), it is possible to monitor and collect important data for tracking costs and for improving the quality of the moulds

New My Mill® App

Streamlined operation through intuitive controls of the next generation SIEMENS touch panel

Intuitive next generation controls

Lower costs

Considerable reduction of mould production costs by removing the pre-production trials

More safety

Lower costs

Intuitive next generation controls

Streamlined operation through intuitive controls of the next generation SIEMENS touch panel

Value of the brand

MILLUTENSIL is a **historic brand** known worldwide since 1955

TELL US ABOUT YOUR UPCOMING SPOTTING PRESS REQUIREMENT (PLEASE ✓), PLEASE FILL OUT THE BELOW APPLICATION FORM AND SEND IT TO US AT info@millutensil.com:

BV SERIE



✓	Model	Platen dimensions (mm) (In)	Clamping force (kN)*
<input type="checkbox"/>	BV 25P	780x660 31x25	180
<input type="checkbox"/>	BV 26C	980x750 38x29	300
<input type="checkbox"/>	BV 26E	980x750 38x29	300
<input type="checkbox"/>	BV 28E	1200x1000 47x39	500
<input type="checkbox"/>	BV 30E	1500x1000 59x39	500
<input type="checkbox"/>	BV 32E - BV 33E	1600x1300 63x51	1200/1500
<input type="checkbox"/>	BV 34E - BV 35E	2000x1500 78x59	1500/2000

All the E- models are available with rotating- and tilting table -
*Further customized dimensions and/or clamping force upon request

MIL CLASSIC SERIE



✓	Model	Platen dimensions (mm) (In)	Clamping force (kN)*
<input type="checkbox"/>	MIL 162-163	1600x1300 63x51	1000/1500
<input type="checkbox"/>	MIL 202-203	2000x1500 78x59	1200/1500
<input type="checkbox"/>	MIL 252-253	2500x1700 98x67	1500/2000
<input type="checkbox"/>	MIL 262-263	2500x2000 98x78	1500/2000
<input type="checkbox"/>	MIL 302-303-304	3000x2000 118x78	2500/3000/4000
<input type="checkbox"/>	MIL 305	3000x2400 118x94	4000/5000
<input type="checkbox"/>	MIL 306	3500x2400 138x94	4000/5000
<input type="checkbox"/>	MIL 307	3500x2500 138x98	4000/5000
<input type="checkbox"/>	MIL 408	4000x2500 157x98	4000/5000
<input type="checkbox"/>	MIL 409	4000x4000 157x157	5000/6000
<input type="checkbox"/>	MIL 509	5000x2500 197x98	5000/6000

Most of the models are available with rotating- and tilting table
*Further customized dimensions and/or clamping force upon request

MIL COMPACT SERIE



✓	Model	Platen dimensions (mm) (In)	Clamping force (kN)*
<input type="checkbox"/>	MIL 2015	2000x1500 78x59	1200/1500
<input type="checkbox"/>	MIL 2520	2500x2000 98x78	1500/2000
<input type="checkbox"/>	MIL 3020	3000x2000 118x78	2500/3000
<input type="checkbox"/>	MIL 3025	3000x2500 118x98	2500/3000
<input type="checkbox"/>	MIL 3030	3000x3000 118x118	3000/4000
<input type="checkbox"/>	MIL 3525	3500x2500 138x98	3000/4000
<input type="checkbox"/>	MIL 3530	3500x3000 138x118	3000/4000
<input type="checkbox"/>	MIL 4030	4000x3000 157x118	3000/4000

*Further customized dimensions and/or clamping force upon request



Download Catalogue BV



Download Catalogue MIL

Company	<input type="text"/>
Contact person	<input type="text"/>
E-mail	<input type="text"/>
Telephone	<input type="text"/>

OUR REFERENCES IN THE WORLD



Office Corso Buenos Aires, 92
20124 Milano - Italia
Tel. +39 02 29404390
Fax +39 02 2046677

Plant Via delle Industrie, 10
26010 Izano (CR) - Italia
info@millutensil.com
millutensil.com







Download Catalogue BV Series



Download Catalogue MIL Series



Office Corso Buenos Aires, 92
20124 Milano - Italia
Tel. +39 02 29404390
Fax +39 02 2046677

Plant Via delle Industrie, 10
26010 Izano (CR) - Italia
info@millutensil.com
millutensil.com

